

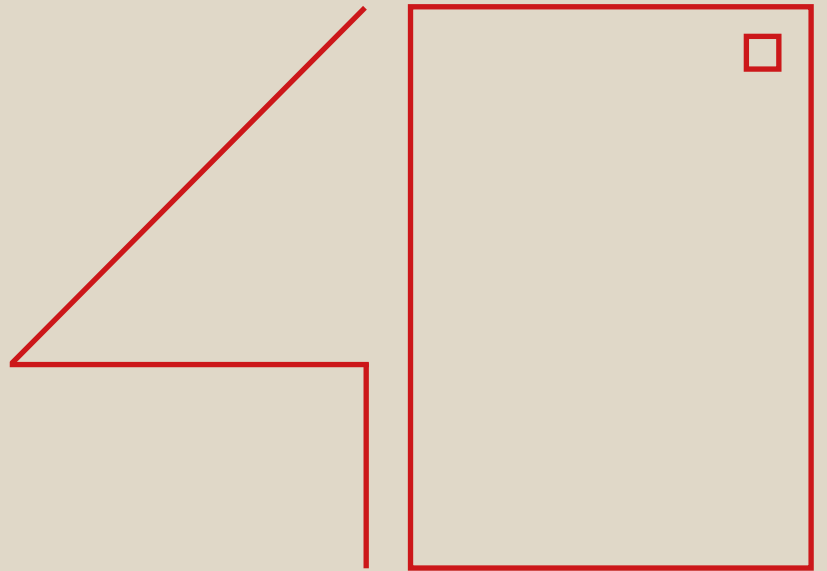









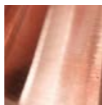





design



Finiture - Finishes

.00  Trasparente <i>Transparent</i>	.25  Dorato satinato <i>Golded satin</i>	.38  Ramatato lucido <i>Shiny copper</i>
.01  Bianco <i>White</i>	.29  Foglia Oro <i>Gold leaf</i>	.45  Alluminio anodizzato <i>Aluminium anodized</i>
.02  Nero <i>Black</i>	.30  Foglia Argento <i>Silver leaf</i>	.56  Specchio <i>Mirror</i>
.05  Rosso <i>Red</i>	.31  Cromato <i>Chromed</i>	.57  Vetro bianco <i>White glass</i>
.14  Lavagna <i>Blackboard</i>	.32  Nichel satinato <i>Nickel mat</i>	
.21  Dorato lucido <i>Shiny golded</i>	.35  Sabbia <i>Sand</i>	

Codice colore luce Light Color Codes

- /XW** Extra White LED 2700K
- /WW** Warm White LED 3000K
- /W** Natural White LED 4000K
- /CW** Cold White LED 5000K

Marchi - Marks



Apparecchio in Classe II, munito di isolamento doppio o rinforzato.

Fixture on Class II, with double or reinforced insulation.



Apparecchio a bassissima tensione con trasformatore remoto.



SELV fixture with remote transformer.





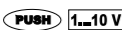

Apparecchio adatto ad essere installato su superfici normalmente incombustibili.

Fixture ready for installation on normally inflammable surfaces.

Codice versioni Option Codes

- /DIM** Dimmerabile
Dimming 
- /DALI** Dimmerabile
Dimming 
- /ST** Con diffusore satinato
Satin diffuser
- /TR** Con diffusore trasparente
Transparent diffuser
- /P** Con protezione IP
IP protection

Simboli Signs

-  Foro incasso.
Cut out.
-  Dimmer incluso
Dimmer included
-  Alimentatore incluso - Alimentatore esterno
Converter included - Converter not included
-  CRI>90 Indice di resa cromatica
CRI>90 Color rendering index
-  Lunghezza cavo
Cable length

www.egoluce.com



LA NOSTRA MISSIONE: MADE IN ITALY

Da sempre **l'Italia è la culla della creatività**.

Know-how e stile italiano sono identificati e apprezzati ovunque, tanto che il **marchio Made in Italy** ha sempre costituito un **valore aggiunto** ricercato in tutto il mondo.

Il prodotto italiano può essere immediatamente riconosciuto grazie **ai dettagli, all'attenzione** e ai **valori estetici** che sono da sempre il nostro biglietto da visita.

Sulla scia di questa grande tradizione, **dal 1978 EGOLUCE crea prodotti 100% Made in Italy**, collaborando principalmente con aziende e artigiani italiani: per offrire ai propri clienti **un prodotto di design con i più alti standard tecnologici**.

La **scelta diligente e attenta dei componenti e dei materiali** di migliore qualità e la lavorazione guidata da criteri di qualità totale, ci consente di produrre e offrire ai nostri clienti una vasta gamma di corpi illuminanti per diverse applicazioni.

Le soluzioni di progettazione illuminotecnica qualificate identificano EgoLuce come uno dei più importanti produttori mondiali di illuminazione.

Prodotti 100% Made in Italy.

40 ANNI DI SUCCESSO

EgoLuce: 40 anni di esperienza per la tua **illuminazione su misura**.

L'evoluzione del prodotto combinato con nuovi materiali, tecnologie e design, sono i reali risultati delle nostre collezioni.

Il know-how e la cura dei dettagli in ogni fase della produzione sono stati una **forza costante** in questi 40 anni di attività di successo.

La capacità nella risoluzione dei problemi, l'attenzione al cliente e a ogni singola **domanda del mercato**, sono una missione costante per Tutti noi!

APPROCCIO UMANO

I sistemi di controllo degli apparecchi considerano il bioritmo umano e incidono positivamente sulla salute e sul benessere.

Un'intelligente gestione dell'energia e del colore della luce danno la possibilità di creare nuovi spazi nel vuoto, regalando allo spettatore una diversa visione dello spazio.

Una nuova **esperienza sensoriale** per la tua anima.

Una luce capace di muoversi e variare nello spazio, in grado di fondersi, di stupire e di appassionare: **una luce indimenticabile**.

La luce **vive nell'ombra** perché il suo flusso è regolato da **soluzioni accattivanti** in ogni versione.



OUR MISSION: MADE IN ITALY

Since ever **Italy is the cradle of creativity**.

An aware production know how and style are identified and commended throughout the world, so much so that the **Made in Italy mark** has always constituted sought-after an **added value**.

An Italian product can immediately be recognized: **details, attention** and the **aesthetic values** are their business card.

In the wake of this great tradition, **since 1978 EGOLUCE has been creating 100% Made in Italy products**, mostly collaborating with Italian companies and craftsmen: in order to offer its clients a **design product with highest technology standard**.

The diligent and **careful selection of best quality components and materials** and the processing guided by criteria such as total quality, enable us to produce and offer to our clients a vast range of light fixtures for several applications.

Qualified Lighting design solutions identify EgoLuce as one of the most important player in the worldwide lighting producer.

Products 100%Made in Italy.

40 YEARS OF SUCCESS

EgoLuce 40 years of experiences for your **tailored lighting** solutions.

Product evolution matches with new material, technologies and design, are actual achievements of Our collections.

Know-how and care in details in every production phases has been a **forceful constant** in these 40 years of successful activity.

Problem solving liability, customer care and attention to each and every **markets demand** are a permanent mission for us.

All of us... This steady Blend!

HUMAN APPROACH

Modern lighting controls take account of the human biorhythm and impact positively on health and well-being.

An **intelligent energy and colour management** of human light **creates** new spaces in empty, as **only an emotional waterfall** can do in You.

A new **sensorial experiences** for your Soul.

Light artful to Move, to Fly, to Melt itself, to Hit inside, to Engage a **simply unforgettable Light**.

Light **survives in the shadow** because its LED glare is shaded **by glamour solutions**.



DESIGN

Il design della luce è **intrinsecamente funzionalità ed estetica** e un approccio progettuale **creativo e adattativo**.

SUL PERCORSO DELL'INNOVAZIONE

Una luce senza tempo in grado di comprendere i nuovi **bisogni umani** in un mondo dinamico in continua rapida evoluzione.

Egoluce propone una luce vissuta come esperienza di vita per **lighting designers**, architetti, progettisti come **partner e interlocutori**.

QUALITÀ IN PRIMO LUOGO

Soluzioni di illuminazione che grazie ad un **alto livello di CRI, offerta di temperature colore, bianco dinamico e UGR**, sono in grado di adattarsi a tutti i progetti di interni ed esterni. fornendo una luce come risposta ai tuoi nuovi **progetti architettonici**.

Una luce capace di disegnare nuove forme nel vuoto per ottenere una esperienza visiva e sensoriale rinnovata.

LA TUA LUCE

Una concezione orientata alla semplificazione del **concetto di design nella vita quotidiana**: una luce che **sa adattarsi** alle esigenze.

Il tempo vola così veloce che la vita si armonizza come la luce per condurre i tuoi sensi in un'**unica sinfonia**.

ECO/EGO

Il riscaldamento globale e l'urgente necessità di **ridurre drasticamente il consumo di energia e le emissioni di CO₂** sono ormai problemi riconosciuti a livello mondiale. In questa nuova era di consapevolezza ognuno ha un ruolo da svolgere, non importa quanto piccolo o grande sia.

EGOLUCE è un'azienda attenta all'ambiente e ha completamente rivisto la sua collezione proponendo nei suoi cataloghi una gamma completa di prodotti a **ridotto consumo energetico**.

Le scelte **eco-compatibili** contribuiscono alla sostenibilità ambientale e sono un tema fondamentale per Egoluce.



DESIGN

Lighting design is both **inherently functional and innately aesthetic**.

Design approach: **generative and adaptive** creativities

Conceptual design based on **metaphors as a heuristic tool**.

ON THE INNOVATION PATH

Timeless light able to figure out new **human needs** in a dynamic surfers world in constant **evolution**.

Egoluce proposes a light lived as a life experience to: Lighting **specialist**, Designers, Architects, Specifiers as **first partners**.

QUALITY FIRST

Lighting solutions that because of: **high CRI level, K° offer, dynamic white and UGR solutions**, are able to adjust themselves to every interiors and exteriors projects.

Egoluce a Light as response to Your new **architectural projects**, light draws spaces in several shapes to get your own sensorial experience.

YOUR OWN LIGHT

A new tradition oriented to the **contemporary context** that **simplifies the new design concept** in our daily life: **adjusting itself** with Your needs.

The time flies by so fast that the life tunes itself with the light to bless your senses **in a symphony**.

ECO/EGO

Global warming and the urgent need to drastically **cut energy consumption and CO₂ emission** are now worldwide recognized problems. In this new era of awareness everyone has a role to play, no matter how small or big.

EGOLUCE is an environmentally conscious company and has totally revised his collection proposing in its catalogues a full range of **low consumption** products.

Eco friendly choices contribute to environment sustainability.

EGOLUCE 40 th

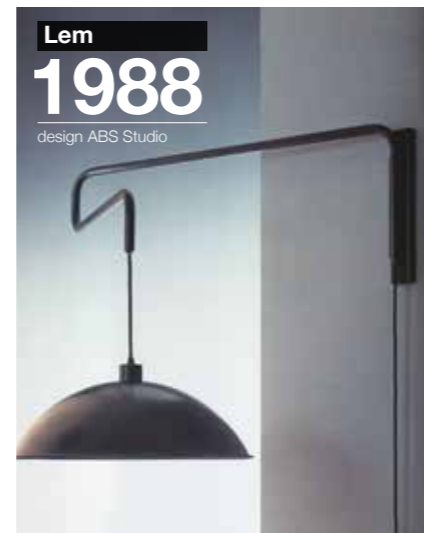
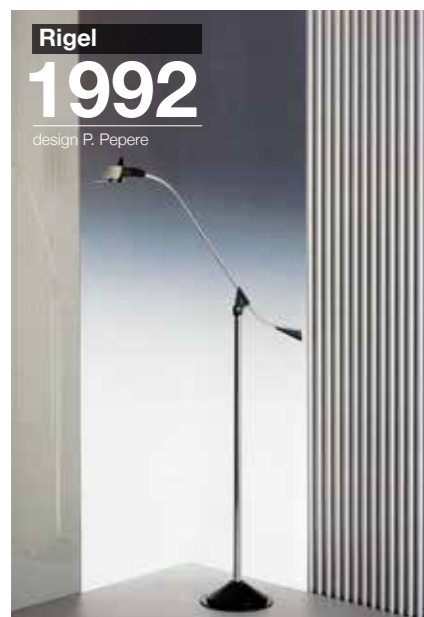
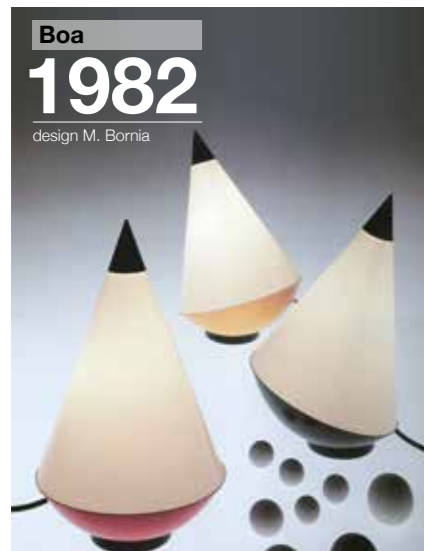

EGOLUCE 40 th

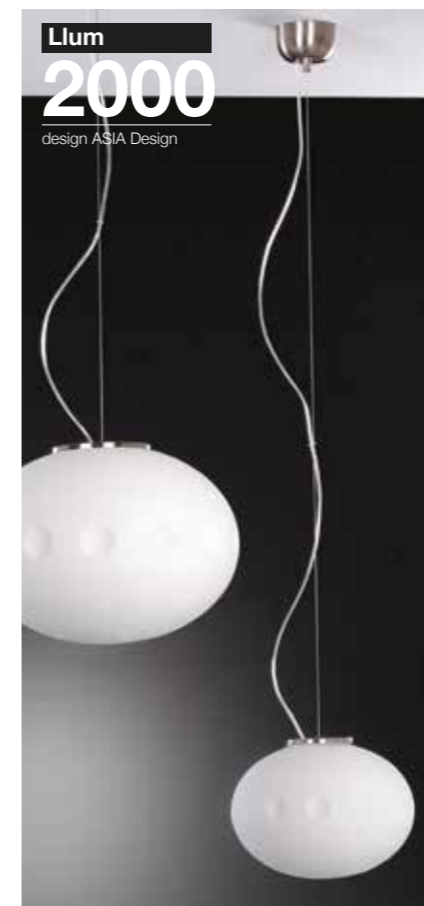

Sospensione - Suspensions



Aerostat p. 281



Alea p. 206



Baloon p. 239



Bureau p. 30



Charme p. 103

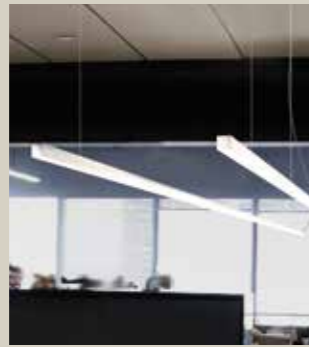

Extra p. 185



Fabric p. 96



Fokus p. 296



Giara p. 283



Kappa p. 251

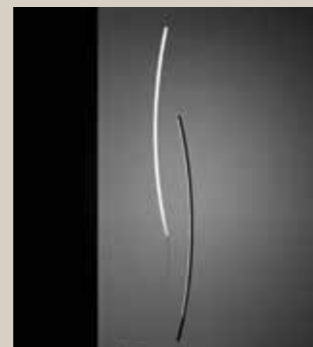

Lancia di Achille p. 23



Lancia sospensione p. 167



Lancia Tonda p. 45



Lei p. 284



Liolà p. 349



Llum p. 356



Lui p. 287



Matassa p. 220



Megavide p. 135



Milady p. 247

Sospensione - Suspensions



Mir p. 382



Mork p. 231



Newton p. 109



Pavillon p. 279



Pevera p. 69



Phantom p. 270



Phantom Maxi p. 271



Pool p. 157



Prêt-à-porter p. 291



Radar p. 91



Rail p. 257



Rail Biemissione p. 259



Rail Quadra p. 163



Rulò p. 191



Slice p. 83



Spirit p. 123



Unidea p. 320

Parete - Wall



Alba p. 343



Alea LED p. 205



Baloon p. 243



Bureau p. 39

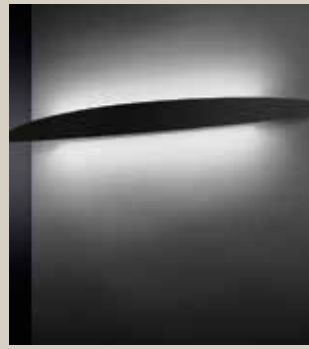

Cl p. 129



Drim p. 365

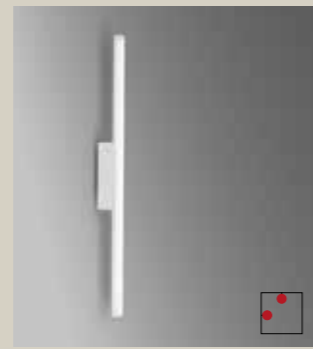

Extra p. 186

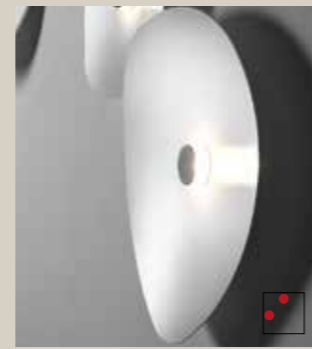

Flower p. 17



Fokus p. 299



Frida p. 362



Fusò p. 366



Ikon - Ikon maxi p. 337



Kalla p. 213



Lancia p. 173

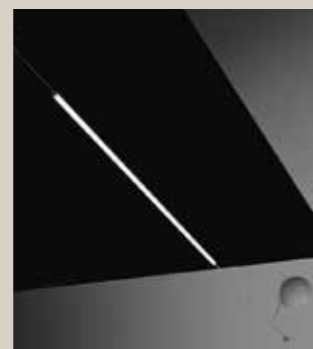

Lancia cavo p. 169



Liola p. 348

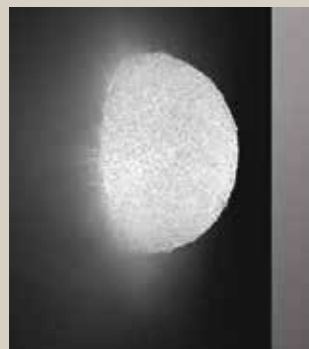

Matassa p. 224



Mats p. 151



Maya p. 386



Minipin p. 378

Parete - Wall



Mirò p. 374

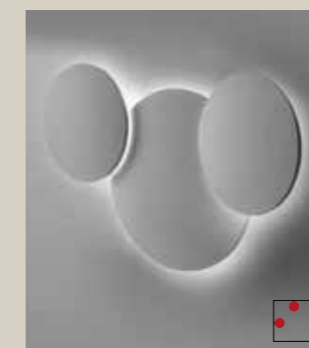

Moonlight p. 55



Morning p. 313



Newton p. 119



Olimpia p. 390



Pupilla p. 143

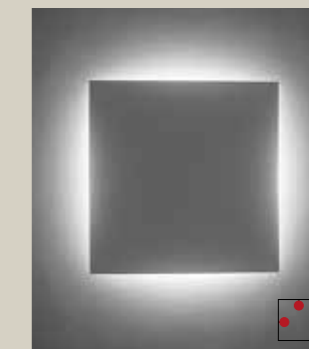

Q light p. 63



Quinta p. 372



Rail p. 265



Read p. 339



Ringo p. 371



Siba p. 317

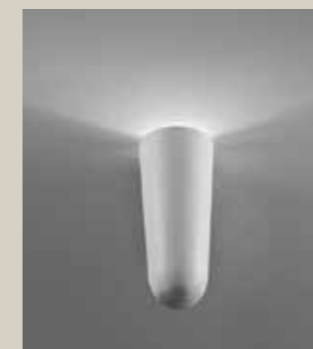

Slice p. 85



Modelli per montaggio sia a parete che soffitto
Models for mounting both wall and ceiling

Tavolo - Table



Alba p. 342



Dama p. 350



Kalla p. 217



Lancia p. 178



Llum p. 357



Unidea p. 331

Soffitto - Ceiling



Alea LED p. 199



Alea Maxi p. 201



Disco p. 392



Drum p. 309

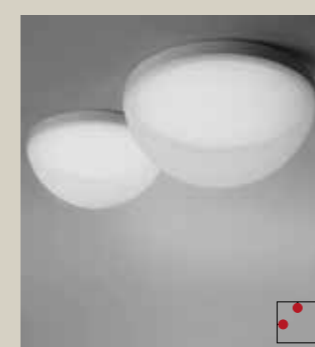

Fabric p. 97



Flip - Flip Maxi p. 376



Helios p. 380



Jazz p. 307

Terra - Floor



Alba p. 340



Baloon p. 241



Bureau p. 35



Dama p. 351



Lancia p. 179

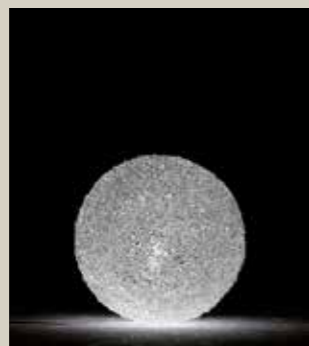

Matassa p. 221



Newton p. 117



Olimpia p. 390



Unidea p. 333



Kappa p. 253

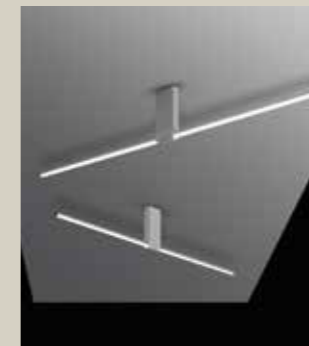

Lancia p. 175



Luna p. 394



Matassa p. 225



Megavide p. 134



Musa p. 369



Phantom p. 272



Phantom Maxi p. 273



Prêt-à-porter p. 293



Rail p. 267



Rail Quadra p. 162



Roc p. 304

Modelli per montaggio sia a parete che soffitto
Models for mounting both wall and ceiling



Serie di lampade da parete/soffitto a luce diffusa

Il taglio asimmetrico del riflettore è l'elemento caratterizzante della lampada che appare diversa da ogni angolazione la si osservi.

La lampada è disponibile in due dimensioni; 40 e 50 cm. di diametro.

FLOWER può essere installata anche in composizioni di più elementi.

La predisposizione per un cablaggio passante permette di accostare più apparecchi partendo da un unico punto luce.

Series of all/ceiling lamps for diffused light. The asymmetrical cut of the reflector is a peculiarity of this product line.

The lamp shape continuously change when seen from different perspectives.

Available in two diameters, 40 and 50cm, FLOWER can also be used to create multiple configurations.

All lamps are predisposed for interconnection allowing installation of more elements on a single power outlet.

Série d'appliques/plafonniers pour lumière diffusé.

Le découpage asymétrique du réflecteur est l'élément esthétique qui caractérise l'appareil. La forme de la lampe semble changer si on la regarde par des différents points de vue.

Disponible en deux diamètres 40 et 50cm. FLOWER peut être utilisé pour créer des configurations multiples.

La prédisposition de chaque appareil pour l'interconnection permet d'installer plusieurs éléments avec un seul point d'alimentation.

Serie von Wand-/deckenleuchten für diffuses Licht.

Die asymmetrische Schnitt des Reflektor ist die ästhetische Besonderheit dieser Leuchte. Der Lampenform wechselt sich, wenn gesehen von unterschiedlichen Standpunkten.

Die Leuchte ist in zwei Durchmesser verfügbar: 40 oder 50 cm.

FLOWER kann auch in Gruppen von mehrere Leuchten installiert werden.

Die Prädisposition für Zwischenverdrahtung ermöglicht die Montage von mehrere Leuchten auf eine einzelne Stromauslass.

Serie de lámparas de pared/techo para luz difusa. El corte asimétrico del reflector es una peculiaridad de esta línea de productos. La forma de la lámpara cambia continuamente cuando se ve desde diferentes perspectivas.

Disponible en dos diámetros, 40 y 50 cm, FLOWER también se puede usar para crear configuraciones múltiples. Todas las lámparas están predispuestas para la interconexión, lo que permite la instalación de más elementos en una sola toma de corriente.

Настенный/потолочный светильник рассеянного света.

Благодаря ассиметричной форме рассеивателя, светильник выглядит по-разному в зависимости от угла зрения.

Предлагается в двух размерах: 40 и 50 см в диаметре.

FLOWER может устанавливаться поодиночке, или в композиции из нескольких элементов.

Предусмотрена возможность последовательно соединить несколько светильников в одну систему



Flower
design S. Cornelissen
2018

Flower
design S. Cornelissen



.01 Bianco - White



.29 Foglia Oro - Gold leaf



.30 Foglia Argento - Silver leaf

Flower è predisposta per cablaggi passanti per la realizzazione di composizioni multiple.
Flower is predisposed for interconnection allowing the creation of multiple configurations.

Flower
design S. Cornelissen

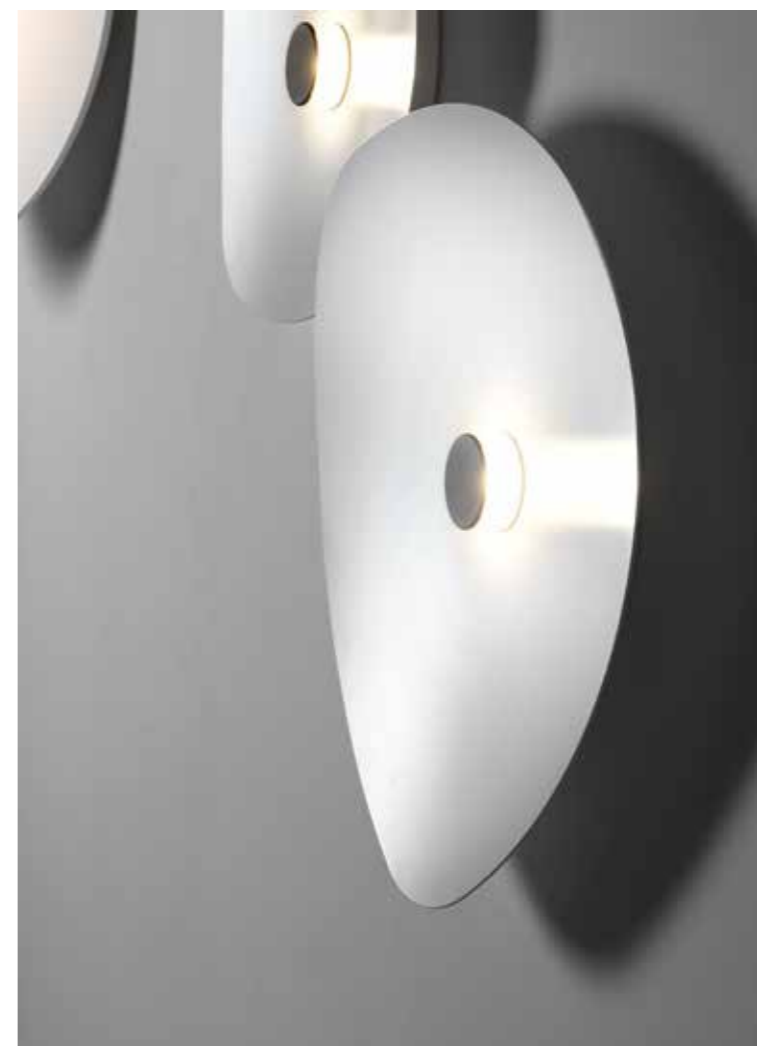

4584	1,6 kg	4585	2,1 kg
.01	Bianco - White	.01	Bianco - White
.29	Foglia Oro - Gold leaf	.29	Foglia Oro - Gold leaf
.30	Foglia Argento - Silver leaf	.30	Foglia Argento - Silver leaf

/WW	LED 12,5W 1936lm 3000K	/WW	LED 12,5W 1936lm 3000K
F	IP 40	F	IP 40
	CRI >90		CRI >90

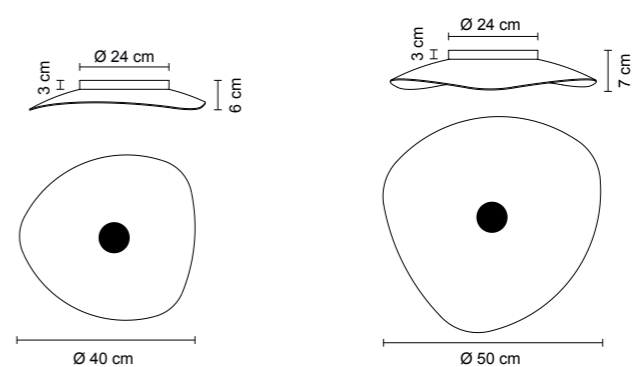

Flower
design S. Cornelissen



Flower
design S. Cornelissen



Lampada da sospensione a luce diffusa scorrevole ed orientabile su cavo in acciaio.

Corpo in alluminio e diffusore in policarbonato opalino.

LANCIA DI ACHILLE con la sua linea semplice ed elegante vuole essere un omaggio ad un'icona del design. Le dimensioni ridotte e la semplicità d'installazione ne consentono l'utilizzo anche in spazi minimi, angoli o dove talvolta è impossibile portare altre fonti di luce.

Suspended Adjustable lamp for diffused light on steel cable.

Lamp frame made of aluminum with opal methacrylate diffuser.

LANCIA DI ACHILLE with its simple and elegant line is a tribute to an icon of design. Reduced dimensions and easiness of installation allows positioning in small areas and corners where there won't be space enough for other lighting solutions.

Suspension réglable pour lumière diffuse glissante sur câble en acier. Corps en aluminium et diffuseur en méthacrylate opalin. LANCIA DI ACHILLE avec sa silhouette simple et élégante est un hommage à une icône du design. Les dimensions réduites et la facilité d'installation permettent le positionnement dans des petites zones et dans des coins où il n'y aura pas assez d'espace pour d'autres solutions d'éclairage.

Einstellbare Pendelleuchte für diffuses Licht auf Stahlkabel. Lampenkörper aus Aluminium mit Opalmethacrylat-Diffusor. LANCIA DI ACHILLE mit seiner schlichten und eleganten Linie ist eine Hommage an eine Ikone des Designs. Reduzierte Abmessungen und einfache Installation ermöglichen die Positionierung in kleinen Bereichen und Ecken, wo nicht genügend Platz für andere Beleuchtungslösungen vorhanden ist.

Lámpara colgante ajustable para luz difusa sobre cable de acero. Cuerpo de perfil de aluminio con difusor de metacrilato opal. LANCIA DI ACHILLE con su línea simple y elegante es un homenaje a un icono del diseño. Las dimensiones reducidas y la facilidad de instalación permiten el posicionamiento en áreas pequeñas y esquinas donde no habrá suficiente espacio para otras soluciones de iluminación.

Подвесной светильник рассеянного света может подниматься и опускаться на стальном тросе, а также направляться в разные стороны. Корпус из алюминия, рассеиватель из матового поликарбоната. Простые, но очень элегантные линии этого светильника являются собой икону стиля. Небольшие размеры и простота установки позволяют использовать его в ограниченных пространствах, где бывает непросто разместить другие источники света.



Lancia di Achille

design P. Peperè

2017

Lancia di Achille
design P. Pepere

Lancia di Achille
design P. Pepere



.02 Nero - Black

.01 Bianco - White

.31 Cromo - Chromed

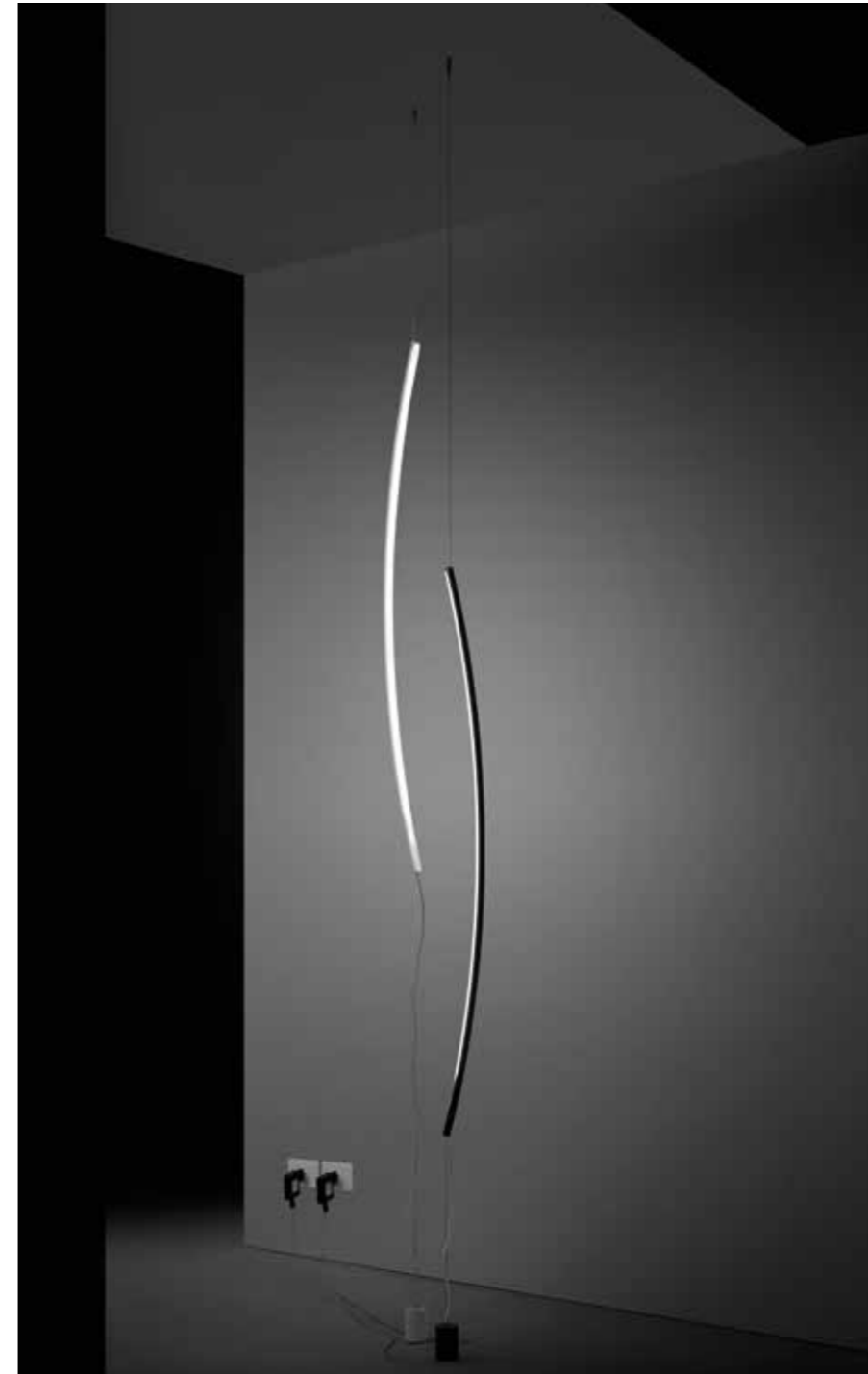

1567 2,8 kg

.01	Bianco - White
.02	Nero - Black
.31	Cromato - Chromed

/W LED 19,5W 2600lm 4000K

/WW LED 19,5W 2578lm 3000K

/XW LED 19,5W 2329lm 2700K

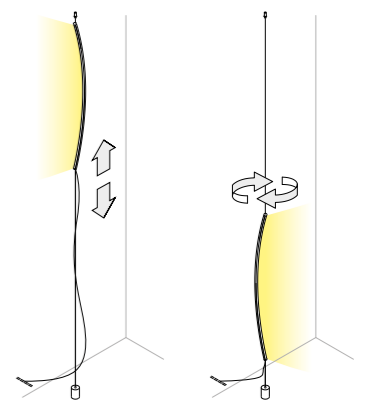
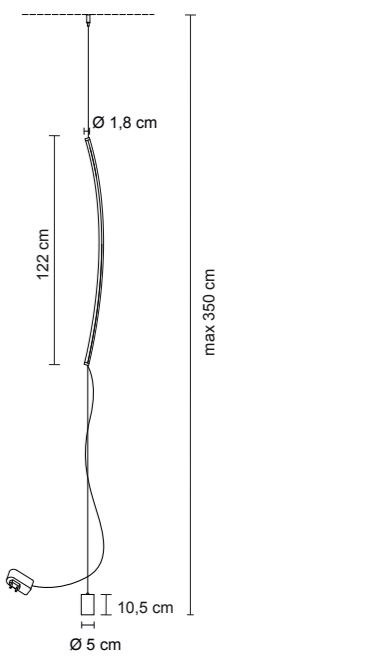

Lancia di Achille

design P. Pepere

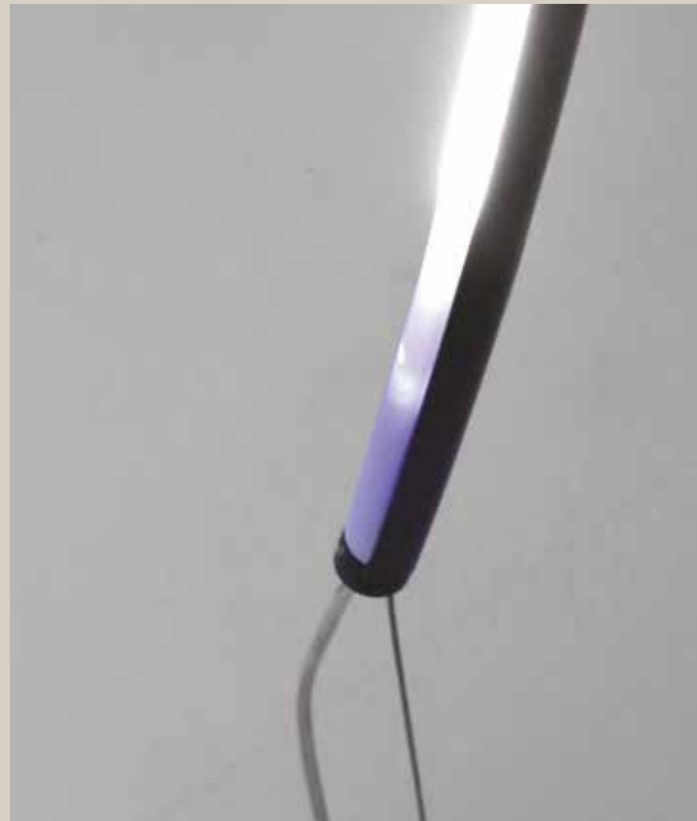

L'interruttore dimmer touch con memoria è integrato nel profilo.
The dimmer-switch with memory is integrated in the stem.



Il contrappeso permette il posizionamento della lampada nel punto desiderato.
The counterweight maintains the lamp in the desired position.

Lancia di Achille

design P. Pepere



La lampada scorre in verticale sul cavo e può essere orientata.
The stem can move and be orientated along the vertical steel cable.

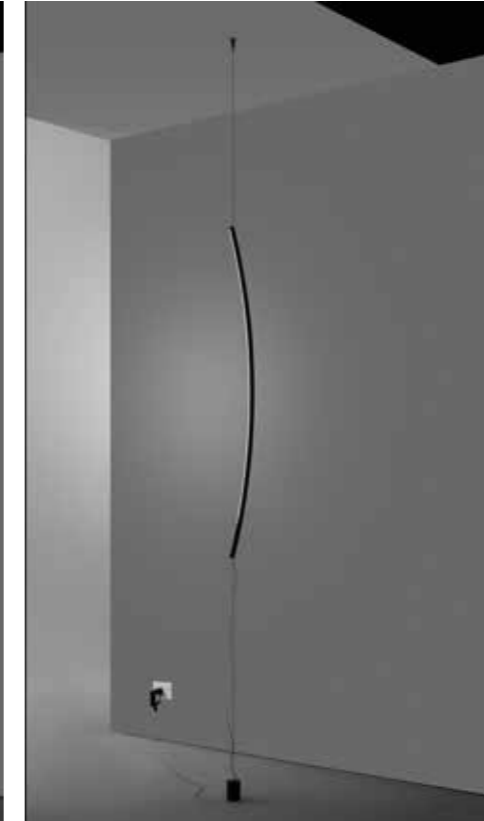

Lancia di Achille
design P. Pepere



Lancia di Achille
design P. Pepere



Collezione di lampade LED a luce indiretta.

Corpo in alluminio con diffusore superiore in metacrilato satinato. Le forme minimal, risultato di un'estrema sintesi geometrica, ben si adattano a qualsiasi ambiente, sia pubblico che privato. Per tutti i modelli sono disponibili versioni dimmerabili.

Collection of LED lamps for indirect light. Lamp body in aluminum topped by a satin methacrylate diffuser. Its minimalist shape, resulting from an extreme geometric synthesis makes it fit for any kind of public or private space. All models are also available in dimmable version.

Série de lampes à LED pour l'éclairage indirect. Structure en aluminium surmonté d'un diffuseur en méthacrylate satiné. Sa forme minimaliste, issue d'une synthèse géométrique extrême, le rend adapté à tout type d'espace public ou privé. Tous les modèles sont également disponibles en version dimmable.

Serie von LED-Lampen für indirektes Licht. Lampengestell aus Aluminium mit Diffusor aus satiniertem Methacrylat. Seine minimalistische Form resultiert aus einer extremen geometrischen Synthese macht es für jede Art von öffentlichen oder privaten Räumen geeignet. Alle Modelle sind auch in dimmbarer Version erhältlich.

Serie de lámparas LED para luz indirecta. Estructura en aluminio cubierta por un difusor de metacrilato satinado. Su forma minimalista, resultado de una síntesis geométrica extrema lo hace apto para cualquier tipo de espacio público o privado. Todos los modelos también están disponibles en versión regulable.

Коллекция светодиодных светильников отраженного света. Корпус из алюминия с рассеивателем из сатинированного метакрилата. Строгие геометрические формы отлично вписываются в любое пространство, как общественное, так и жилое. Для всех моделей есть диммируемые варианты.

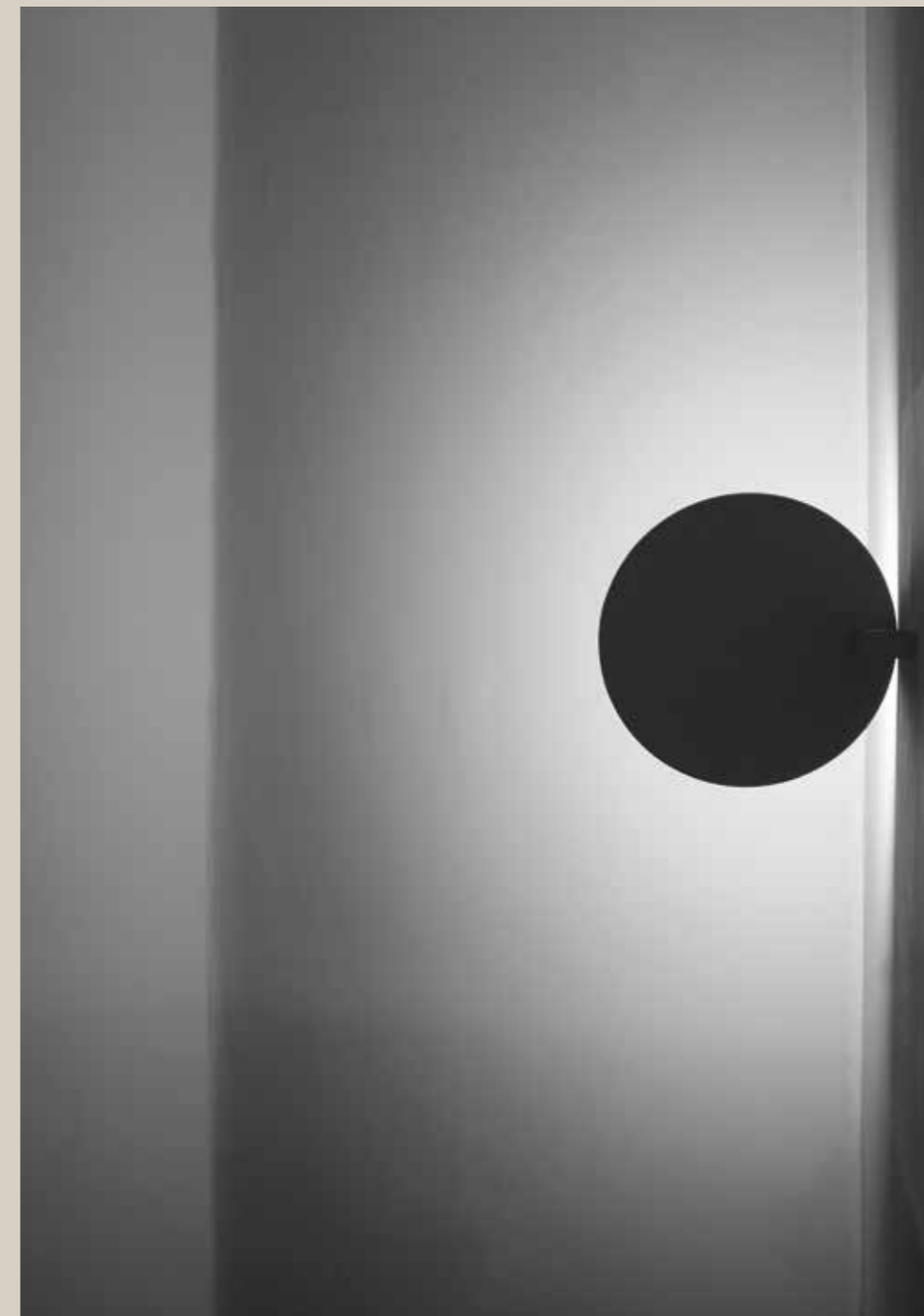

Bureau
design Mati
2017



Esempio d'installazione con piastra in cartongesso (1554 + 0959).
Example of installation with plate for plasterboard false ceilings (1554 + 0959).

1554 1,2 kg

.01 Bianco - White
.02 Nero - Black

/W LED 25,3W 4080lm 4000K

/WW LED 25,3W 3880lm 3000K

/XW LED 25,3W 3720lm 2700K

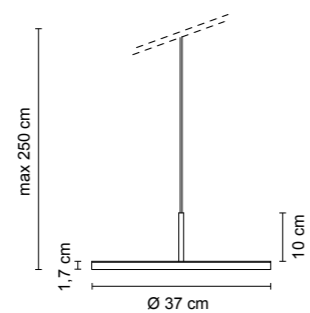

Accessori - Accessories

0955 0,6 kg

Rosone completo di alimentatore - **1 Bureau**
Ceiling rose with converter - **1 Bureau**

.01 Bianco - White

.02 Nero - Black

50/60Hz 220-240V



0955 dim PUSH 1...10V 0,6 kg

Rosone completo di alimentatore DIMMERABILE PUSH 1...10V - **1 Bureau**
Ceiling rose with DIMMABLE PUSH 1...10V converter - **1 Bureau**

.01/DIM Bianco - White

.02/DIM Nero - Black

50/60Hz 220-240V



0955 dim DALI 0,6 kg

Rosone completo di alimentatore DIMMERABILE DALI - **1 Bureau**
Ceiling rose with DIMMABLE DALI converter - **1 Bureau**

.01/DALI Bianco - White

.02/DALI Nero - Black

50/60Hz 220-240V

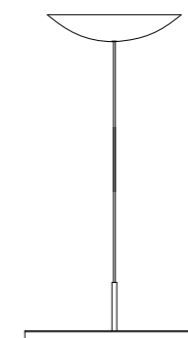
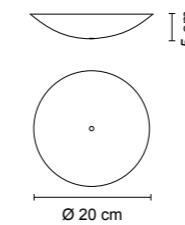

1554 + 0955

0959 0,3 kg

Piastra per cartongesso con alimentatore - **1 Bureau**
Plasterboard ceiling rose with converter - **1 Bureau**

.01 Bianco - White

.02 Nero - Black

50/60Hz 220-240V



0959 dim PUSH 1...10V 0,3 kg

Piastra per cartongesso con alimentatore DIMMERABILE PUSH 1...10V - **1 Bureau**
Plasterboard ceiling rose with DIMMABLE PUSH 1...10V converter - **1 Bureau**

.01/DIM Bianco - White

.02/DIM Nero - Black

50/60Hz 220-240V



0959 dim DALI 0,3 kg

Piastra per cartongesso con alimentatore DIMMERABILE DALI - **1 Bureau**
Plasterboard ceiling rose with DIMMABLE DALI converter - **1 Bureau**

.01/DALI Bianco - White

.02/DALI Nero - Black

50/60Hz 220-240V

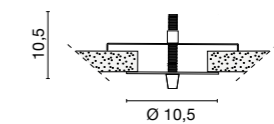

9,5 cm.

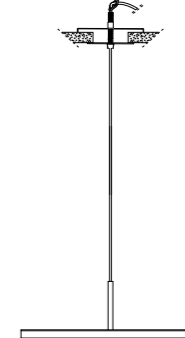

1554 + 0959





3508 8,5 kg

- .01** Bianco - White
- .02** Nero - Black
- .05** Rosso - Red

- /W** LED 25,3W 4080lm 4000K
- /WW** LED 25,3W 3880lm 3000K
- /XW** LED 25,3W 3720lm 2700K



3509 dim 8,5 kg

- .01** Bianco - White
- .02** Nero - Black
- .05** Rosso - Red

- /W** LED 25,3W 4080lm 4000K
- /WW** LED 25,3W 3880lm 3000K
- /XW** LED 25,3W 3720lm 2700K

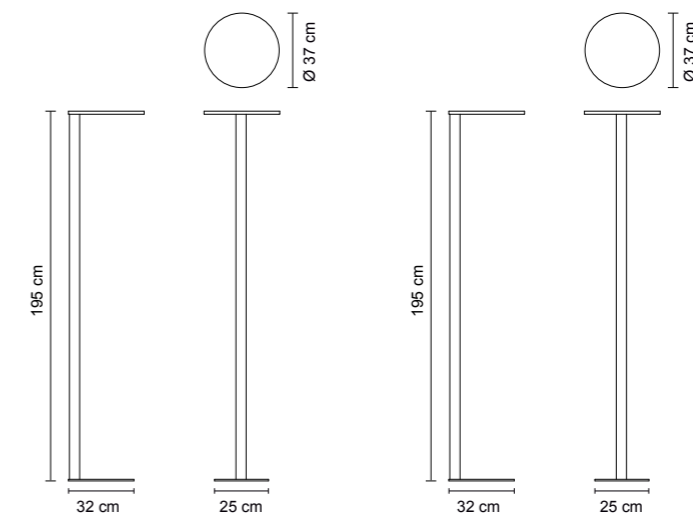

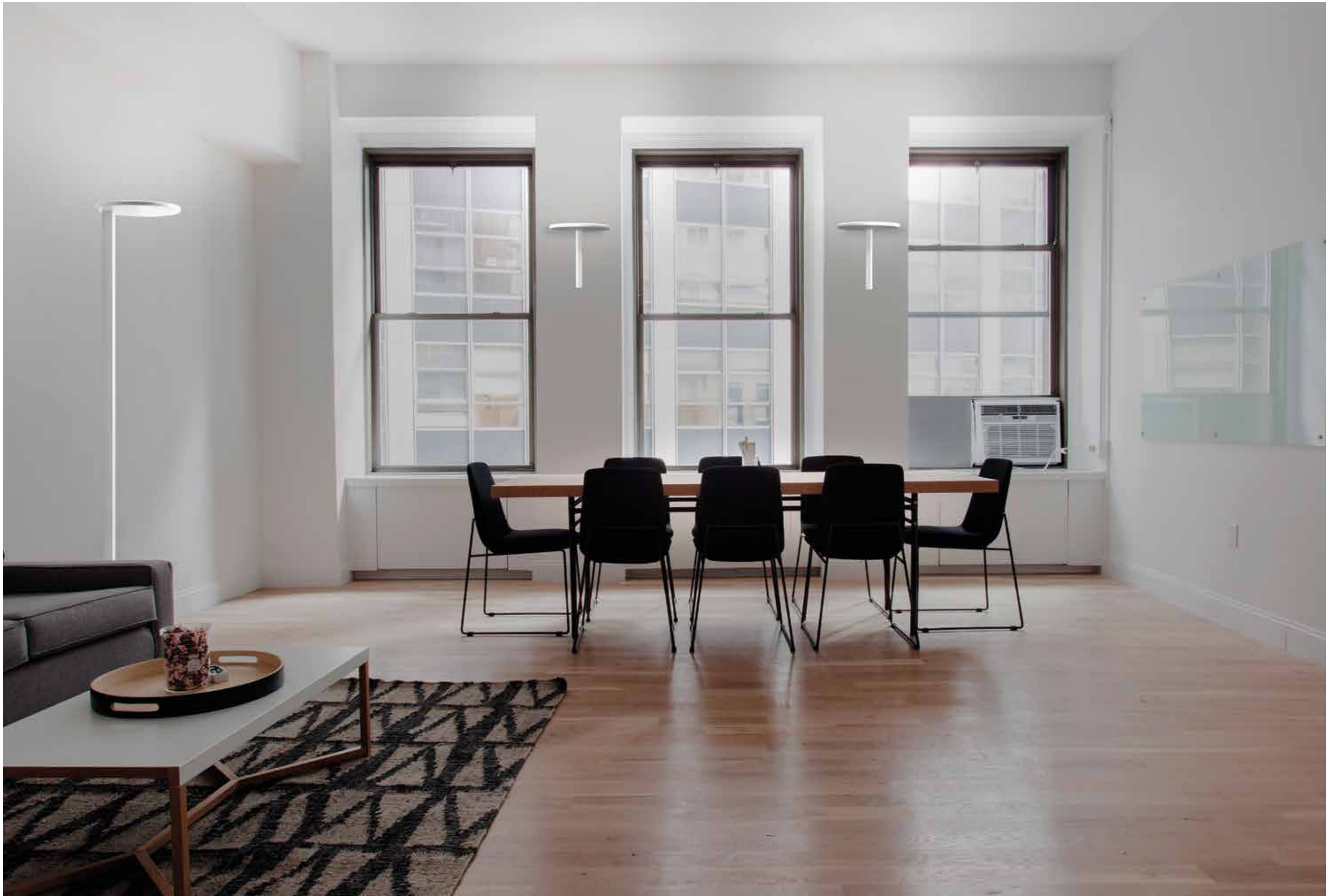



4587 1,7 kg

.01	Bianco - White
.02	Nero - Black
.05	Rosso - Red

/W LED 25,3W 4080lm 4000K

/WW LED 25,3W 3880lm 3000K

/XW LED 25,3W 3720lm 2700K

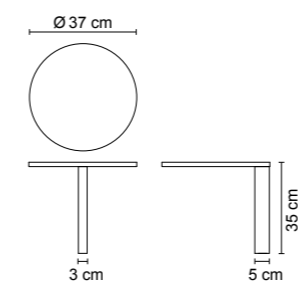

4588 dim PUSH 1...10V 2 kg

.01	Bianco - White
.02	Nero - Black
.05	Rosso - Red

/W/DIM LED 25,3W 4080lm 4000K

/WW/DIM LED 25,3W 3880lm 3000K

/XW/DIM LED 25,3W 3720lm 2700K

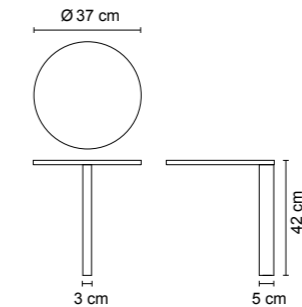

4588 dim DALI 2 kg

.01	Bianco - White
.02	Nero - Black
.05	Rosso - Red

/W/DALI LED 25,3W 4080lm 4000K

/WW/DALI LED 25,3W 3880lm 3000K

/XW/DALI LED 25,3W 3720lm 2700K

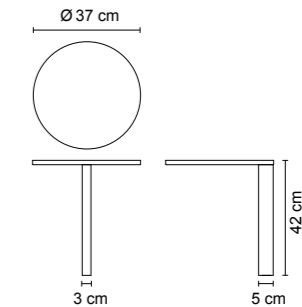

**Lampade a sospensione a luce LED.
Corpo in alluminio con diffusore in
policarbonato opalino.
La sola versione con diametro 70 cm. è
disponibile anche in cromo lucido ed
oro spazzolato.
La luce uniforme è rivolta all'interno del
cerchio.
A richiesta sono disponibili versioni
dimmerabili.**

Series of suspension lamps for diffused
LED light. The lamp structure is composed
by an extruded aluminum profile with
opal polycarbonate diffuser. The smallest
option, diameter 70 cm, is also available
in chrome finish or satin gold. A uniform
light flows towards the inner part of the
circle. Dimmable options are available upon
request.

Série suspensions pour lumière LED
diffuse.
Structure en profil d'aluminium extrudé
avec diffuseur en polycarbonate opalin.
La version plus petite, diamètre 70 cm, est
également disponible en finition chromée
ou en or brossé.
Une lumière uniforme se dirige vers la partie
intérieure du cercle.
Des options de gradables sont disponibles
sur demande.

Serie von Hängeleuchten für diffuses
LED-Licht. Struktur aus Aluminiumprofil mit
opalem Polycarbonat-Diffusor.
Die kleinste Variante, Durchmesser 70 cm,
ist auch in Chrom oder
gebürstetem Gold erhältlich.
Ein homogenes Licht fließt in Richtung der
Mittel des Kreises.
Dimmbare Optionen sind auf Anfrage
erhältlich.

Serie de colgantes para luz LED difusa.
Estructura en perfil de aluminio extruido
con difusor de policarbonato opal.
La opción más pequeña, diámetro 70 cm,
también está disponible en acabado
cromado o en oro cepillado.
Una luz uniforme fluye hacia la parte interna
del círculo.
Las opciones regulables están disponibles
bajo petición.

Подвесной светодиодный светильник.
Корпус из алюминия,
рассеиватель из матового
поликарбоната. Модель 70 см
в диаметре существует также в отделке
блестящий хром и
брашированное золото.
Внутри круга свет ложится очень ровно.
По запросу имеются диммируемые
варианты.

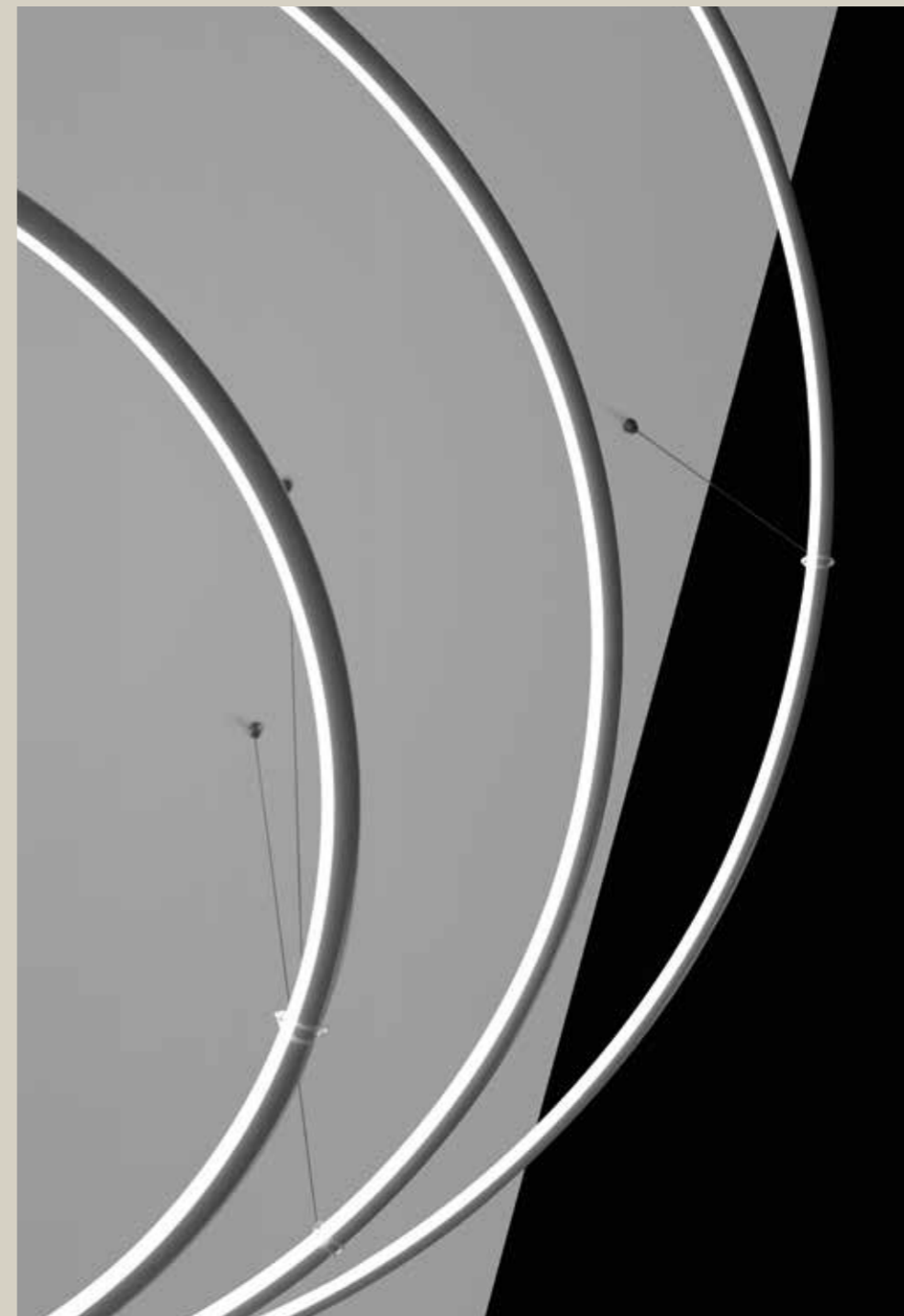

Lancia Tonda

design P. Peperè

2017

Lancia Tonda
design P. Pepere



Lancia Tonda
design P. Pepere

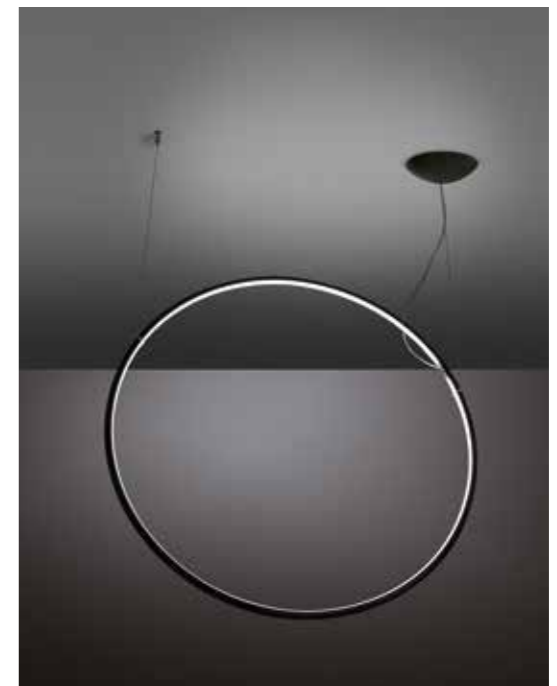

Lancia Tonda

design P. Pepere



.01 Bianco - White



.02 Nero - Black



.31 Cromo - Chromed



.25 Dorato satinato - Satin gold

Lancia Tonda

design P. Pepere

1562 1,10 kg

- .01 Bianco - White
- .02 Nero - Black
- .25 Dorato satinato - Satin gold
- .31 Cromato - Chromed

- /W LED 37,5W 5000lm 4000K
- /WW LED 37,5W 4958lm 3000K
- /XW LED 37,5W 4479lm 2700K

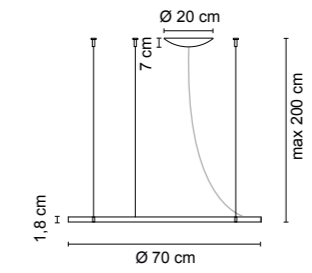

1563 1,45 kg

- .01 Bianco - White
- .02 Nero - Black

- /W LED 54W 7200lm 4000K
- /WW LED 54W 7140lm 3000K
- /XW LED 54W 6450lm 2700K

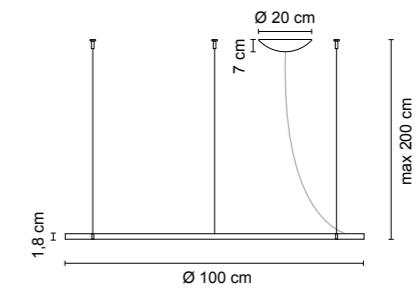

1564 2,35 kg

- .01 Bianco - White
- .02 Nero - Black

- /W LED 81W 10800lm 4000K
- /WW LED 81W 10710lm 3000K
- /XW LED 81W 9675lm 2700K

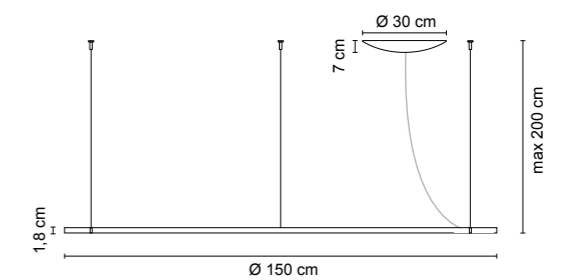

Lancia Tonda System

design P. Pepere



A1562.01/... + A1563.01/... + A1564.01... + 3 0091/A + 0990/200



A1562.01/... + A1563.01/... + A1564.01... + 3 0091/A + 0990/200

Lancia Tonda System

design P. Pepere

LED source 24V - 18W/mt

Composizioni multiple - Multiple installations

Codice Code	Ø cm	watt	Finitura Finishes	LED color 2700K		LED color 3000K		LED color 4000K	
				Lm	Lm	Lm	Lm		
A1562	70	37,5	.01 Bianco - White	/XW	4479	/WW	4958	/W	5000
A1562	70	37,5	.02 Nero - Black	/XW	4479	/WW	4958	/W	5000
A1562	70	37,5	.25 Dorato satinato - Satin gold	/XW	4479	/WW	4958	/W	5000
A1562	70	37,5	.31 Cromato - Chromed	/XW	4479	/WW	4958	/W	5000
A1563	100	54	.01 Bianco - White	/XW	6450	/WW	7140	/W	7200
A1563	100	54	.02 Nero - Black	/XW	6450	/WW	7140	/W	7200
A1564	150	81	.01 Bianco - White	/XW	9675	/WW	10710	/W	10800
A1564	150	81	.02 Nero - Black	/XW	9675	/WW	10710	/W	10800



Lunghezza del cavo elettrico 250cm - Electric cable length 250cm

0990/150 2 kg

Rosone completo di alimentatore 150W
Ceiling rose with converter 150W

- .01 Bianco - White
- .02 Nero - Black

50/60Hz 220-240V - 150W

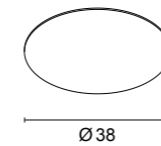

0990/200 2 kg

Rosone completo di alimentatori 2x100W
Ceiling rose with converters 2x100W

- .01 Bianco - White
- .02 Nero - Black

50/60Hz 220-240V - 2x100W

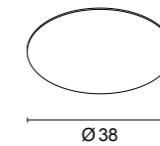

0991/A

Kit fissaggio singola lampada
Single lamp cable kit

- 3 Cavi acciaio 2mt.
- 3 Decentratori fissaggio cavo.
- 3 Clip reggi lampadina.

- 3 Steel cables 2mt.
- 3 Element for cable fixing.
- 3 Suspension clips.



Tabella esempi combinazioni: Table of combinations:

Ø cm	Watt	codice code	0990/150						0990/200					
			1	2	3	4	5	6	1	2	3	4	5	6
70	37,5	A1562	1		1	2	3			1	2		4	3
100	54	A1563	1	1		1		2		1				1
150	81	A1564			1	1				1	1	2		

Lancia Tonda System

design P. Pepere

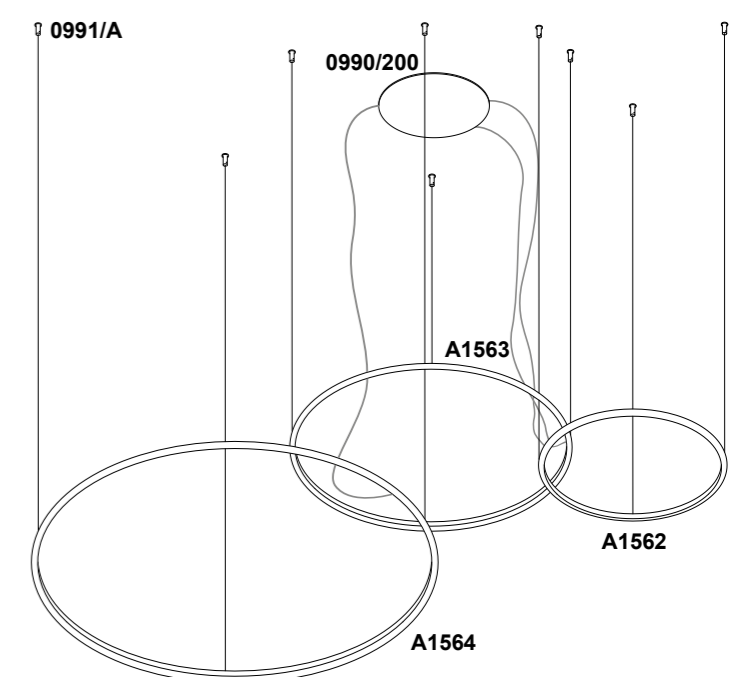
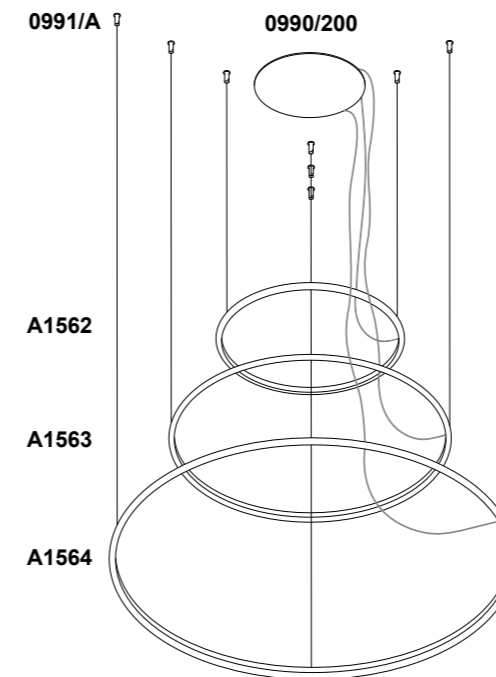
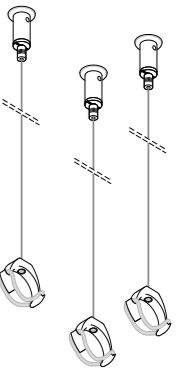

A1562.01/... + A1563.01/... + A1564.01... + 3 0091/B + 0990/200

Lancia Tonda System

design P. Pepere

LED source 24V - 18W/mt

Composizioni multiple - Multiple installations

Codice Code	Ø cm	watt	Finitura Finishes	LED color 2700K		LED color 3000K		LED color 4000K	
				Lm	Lm	Lm	Lm		
A1562	70	37,5	.01 Bianco - White	/XW 4479	/WW 4958	/W 5000			
A1562	70	37,5	.02 Nero - Black	/XW 4479	/WW 4958	/W 5000			
A1562	70	37,5	.25 Dorato satinato - Satin gold	/XW 4479	/WW 4958	/W 5000			
A1562	70	37,5	.31 Cromato - Chromed	/XW 4479	/WW 4958	/W 5000			
A1563	100	54	.01 Bianco - White	/XW 6450	/WW 7140	/W 7200			
A1563	100	54	.02 Nero - Black	/XW 6450	/WW 7140	/W 7200			
A1564	150	81	.01 Bianco - White	/XW 9675	/WW 10710	/W 10800			
A1564	150	81	.02 Nero - Black	/XW 9675	/WW 10710	/W 10800			



Lunghezza del cavo elettrico 250cm - Electric cable length 250cm

0990/150 2 kg
Rosone completo di alimentatore **150W**
Ceiling rose with converter **150W**
.01 Bianco - White
.02 Nero - Black

50/60Hz 220-240V - 150W

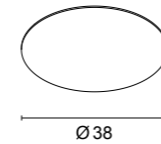

0990/200 2 kg
Rosone completo di alimentatori **2x100W**
Ceiling rose with converters **2x100W**
.01 Bianco - White
.02 Nero - Black

50/60Hz 220-240V - 2x100W

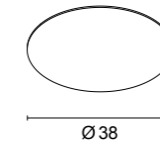

0991/B
Kit fissaggio composizioni 3 lampade
3 lamps cable kit

3 Cavi acciaio 4mt.
1 Decentratore fissaggio cavi.
3 Clip reggi lampadina.

3 Stell cables 4mt.
1 Displacement element for cable fixing.
3 Suspension clips.



Tabella esempi combinazioni: Table of combinations:

Ø cm	Watt	codice code	0990/150						0990/200			
			1	1	1	2	3	2	1	2	2	
70	37,5	A1562	1									
100	54	A1563	1	1		1			2			
150	81	A1564			1					1	1	2

Lancia Tonda
design P. Peperè

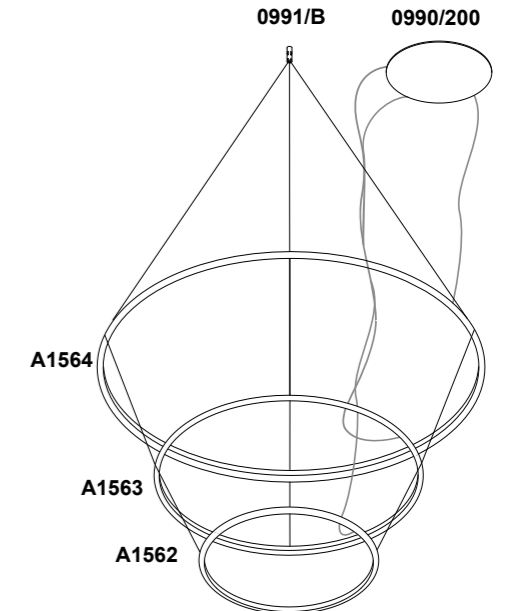
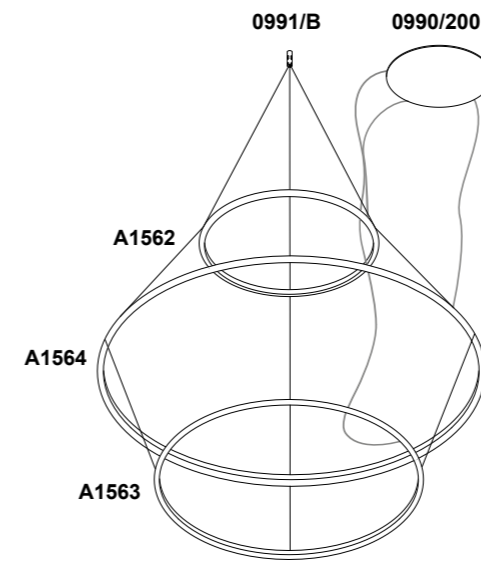
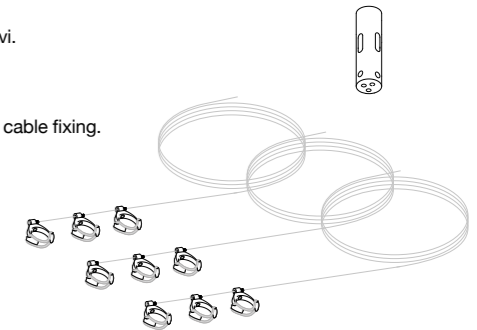

Lancia Tonda
design P. Peperè



Lampade da parete o soffitto con emissione radiale.
Alimentatore integrato, versioni dimmerabili a richiesta.
La versione grezza (.01) del disco frontale in MDF richiede una ulteriore finitura con idropittura od altro a scelta.
Sono disponibili le seguenti versioni finite: verniciata lavagna, foglia oro o foglia argento.
La sola versione piccola è disponibile anche con specchio.
Partendo da un unico punto di alimentazione è possibile creare composizioni intersecando più elementi grazie ad un apposito kit da ordinare separatamente (Art. 0963).

Ceiling/wall lamp for radial light emission. In the raw version .01 the frontal MDF panel requires further finishing with water paint or other varnishes at choice. Following finished versions are available: blackboard, gold leaf, silver leaf. Only the smaller option is also available with mirror. It is possible to create compositions overlapping more elements by means of a specific kit (Art. 0963) to be ordered separately.

Plafonnier / applique pour l'émission de lumière radiale. Dans la version brute .01, le panneau MDF frontal nécessite d'une ultérieure finition à choix avec teinte à l'eau ou d'autres vernis. Autres versions disponibles: tableau noir, feuille d'or, feuille d'argent. Seulement la petite version est disponible avec miroir. C'est possible de créer des compositions superposant plusieurs éléments grâce à un kit spécifique (Art 0963) à commander séparément.

Decken- / Wandleuchte für radiale Lichtemission. In der Rohversion .01 muss die Frontplatte aus MDF mit Wasserfarbe oder anderen Lacken nachbearbeitet werden. Fertige Versionen: Schultafel, Blattgold, Blattsilber. Nur die kleinere Option ist mit Spiegel verfügbar. Mit einem spezifischen Kit (Art. 0963), das separat zu bestellen ist, kann man eine Komposition zu erstellen, die mehrere Elemente überlappt.

Lámpara de techo/pared para emisión de luz radial. En la versión bruta .01, el panel frontal de MDF requiere un acabado adicional con pintura al agua u otros barnices a elección. El producto es también disponible en las versiones siguientes: pizarra, hoja de oro, hoja de plata. Solo la opción pequeña también está disponible con espejo. Mediante un kit específico (Art. 0963), que debe pedirse por separado, es posible crear composiciones superponiendo más elementos.

Настенные и потолочный светильник брющего света. Блок питания встроен. По запросу есть диммируемые варианты. После установки необходимо закрасить переднюю панель обычной вододисперсионной краской. Светильник меньшего диаметра может быть с зеркальной поверхностью, либо с отделкой из сусального золота или сусального серебра. Подключаясь из одной точки, можно создать разные композиции, накладывающиеся друг на друга благодаря специальному монтажному набору, который заказывается отдельно (арт. 0963).

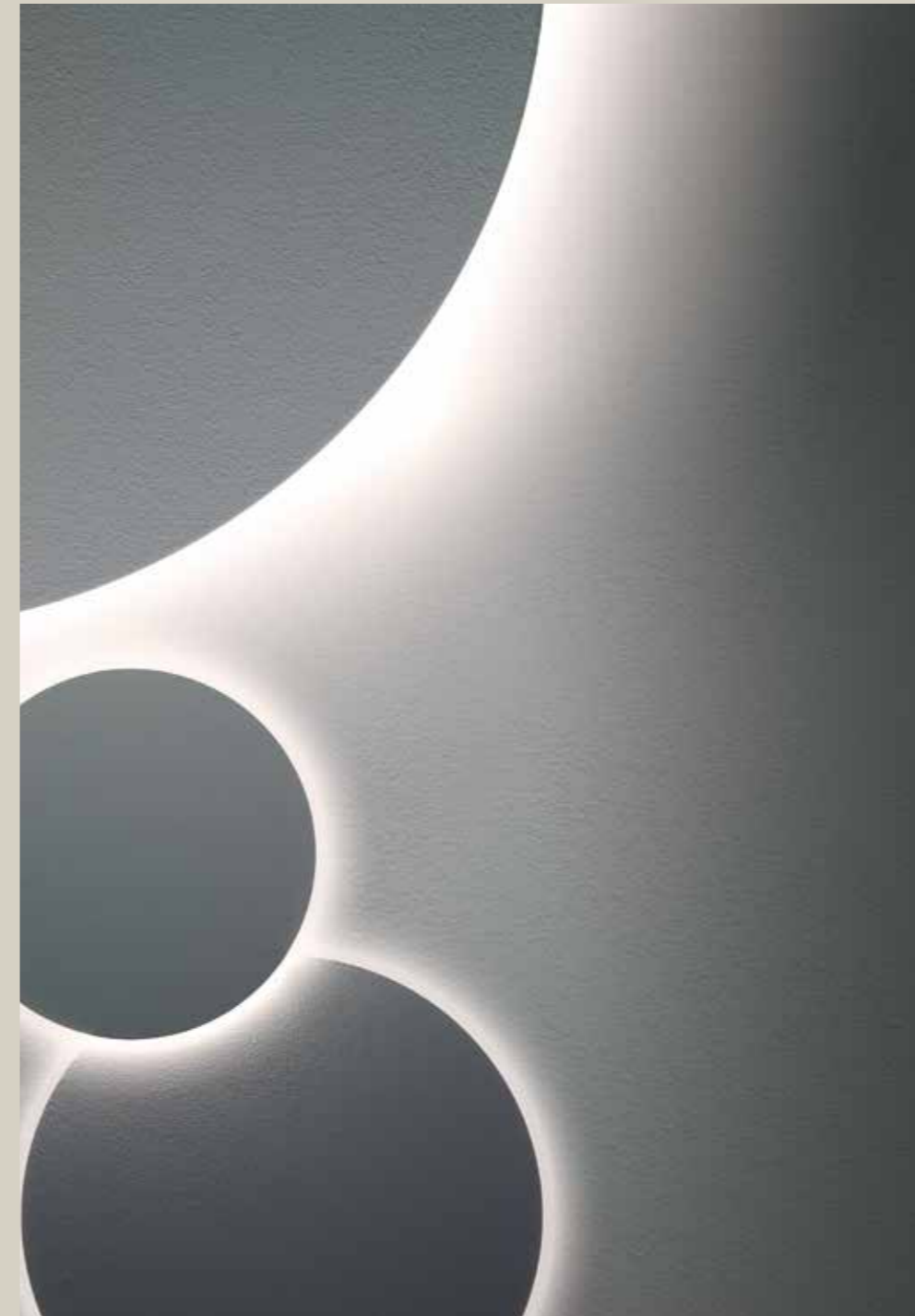

Moonlight
design ABS Studio
2016

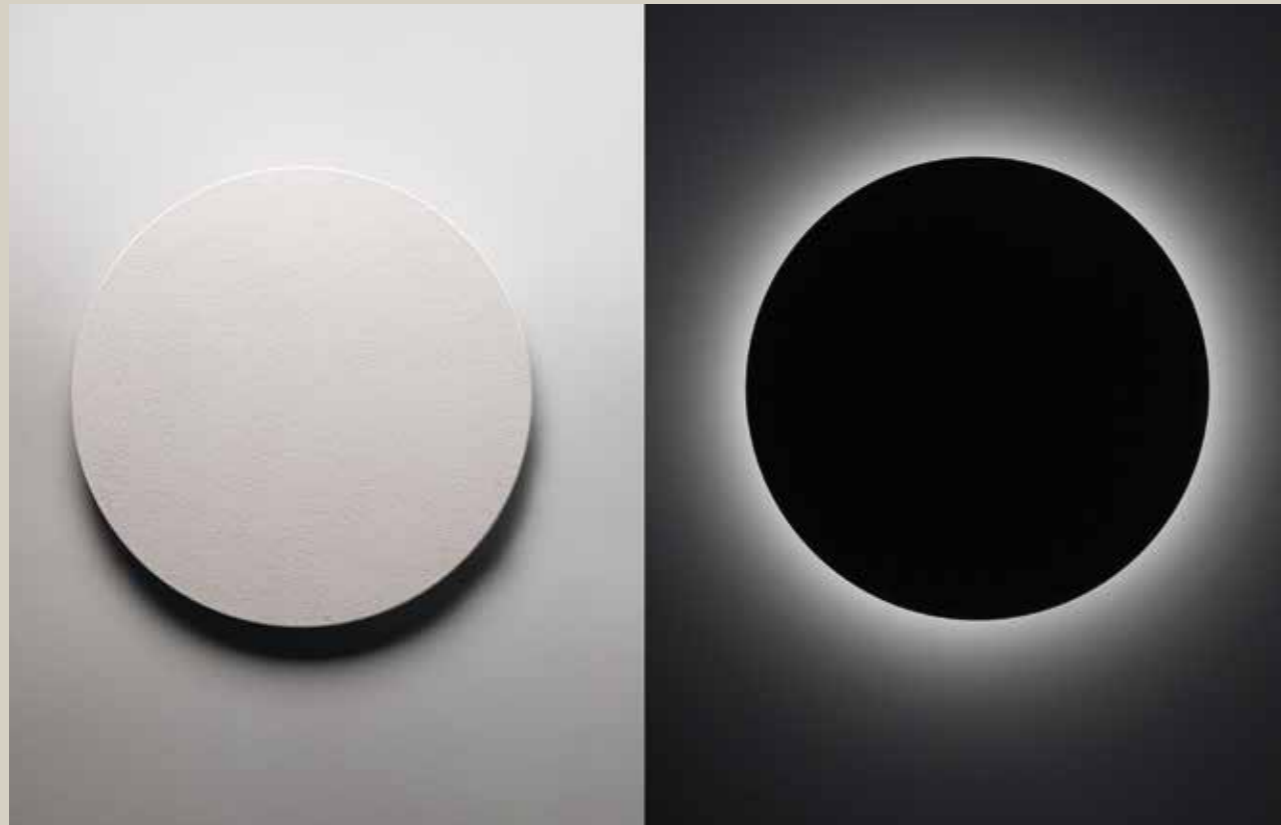

.01 Bianco grezzo da finire
Raw white to be painted

.14 Lavagna
Blackboard

.29 Foglia Oro
Gold leaf

.30 Foglia Argento
Silver leaf

.56 Specchio - Mirror



4582.01/... + 4583.01/... + 0963.01

4582	1,8 kg
.01	Bianco grezzo - Raw white
.14	Lavagna - Blackboard
.29	Foglia oro - Gold leaf
.30	Foglia argento - Silver leaf
.56	Specchio - Mirror 2,80 kg

/W	LED 15W 2000lm 4000K
/WW	LED 15W 1900lm 3000K
/XW	LED 15W 1780lm 2700K

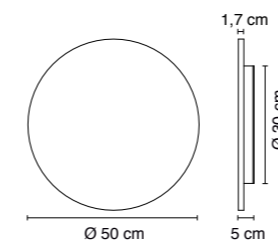
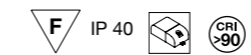

4583	3,0 kg
.01	Bianco grezzo - Raw white
.14	Lavagna - Blackboard
.29	Foglia oro - Gold leaf
.30	Foglia argento - Silver leaf

/W	LED 24W 3200lm 4000K
/WW	LED 24W 3040lm 3000K
/XW	LED 24W 2848lm 2700K

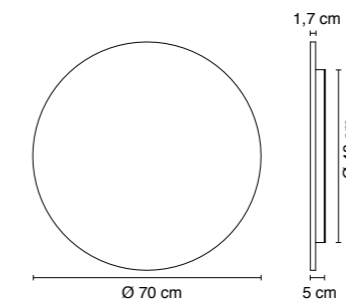
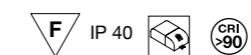

0963	0,3 kg
Distanziale per composizioni multiple Kit for overlapping	
.01	Bianco - White

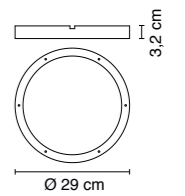

Moonlight

design ABS Studio

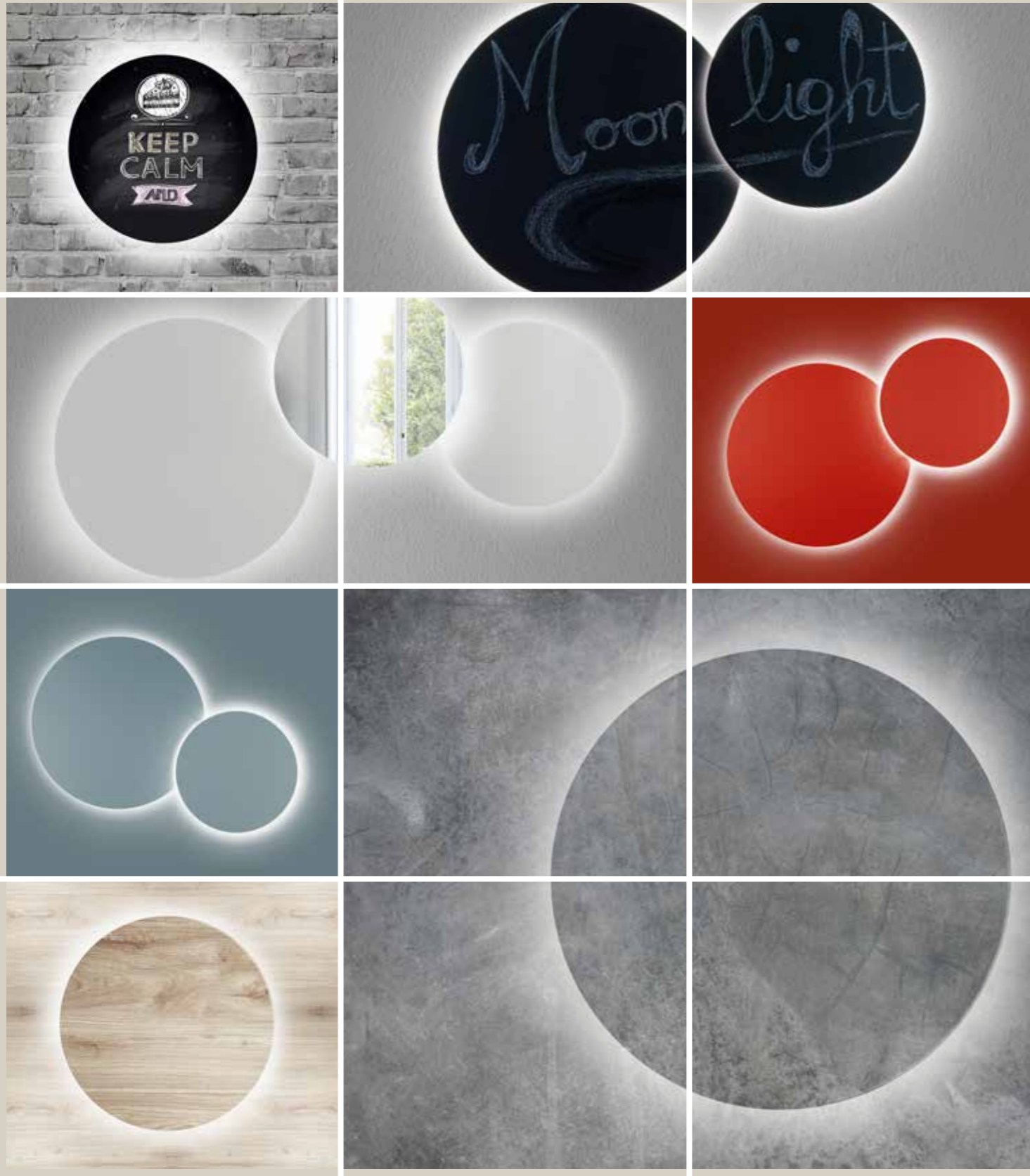

Moonlight

design ABS Studio

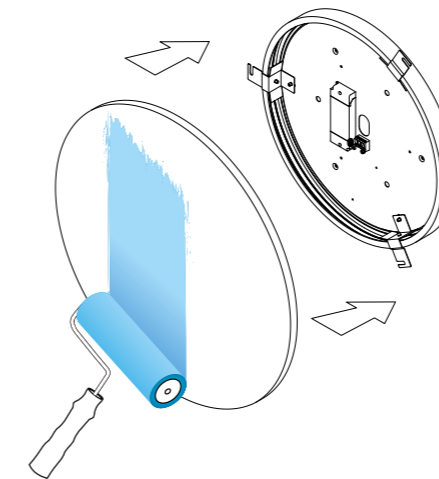
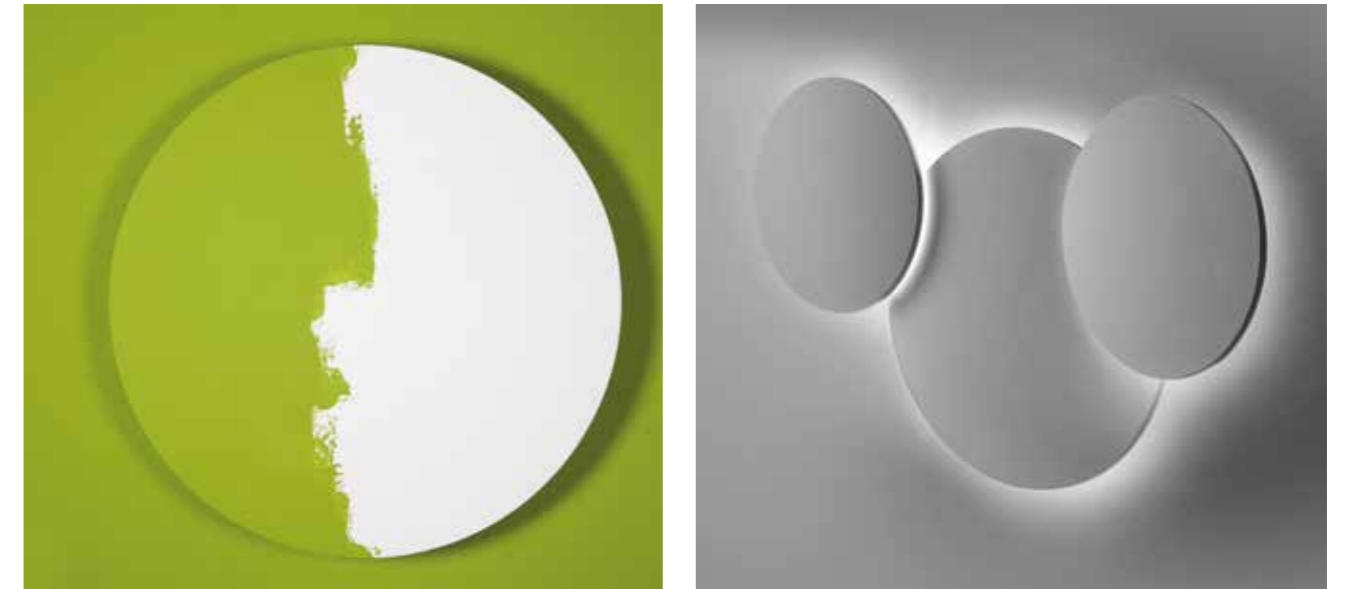

Esempio di installazione singola.
Example of single installation.

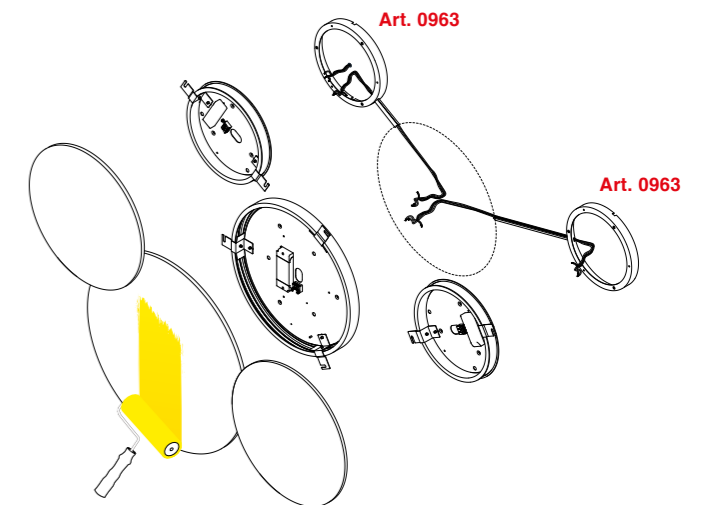

Esempio di installazione multipla con distanziali.
Example of multiple installation with spacers.



Lampade da parete o soffitto con emissione radiale.

Alimentatore integrato, versioni dimmerabili a richiesta.

La versione grezza (.01) del frontale in MDF richiede una ulteriore finitura con idropittura od altro a scelta.

Sono disponibili le seguenti versioni finite: verniciata lavagna, foglia oro o foglia argento.

La sola versione piccola è disponibile anche con specchio.

Partendo da un unico punto di alimentazione è possibile creare composizioni intersecando più elementi grazie ad un apposito kit da ordinare separatamente (Art. 0963).

Ceiling/wall lamp for radial light emission. In the raw version .01 the frontal MDF panel requires further finishing with water paint or other varnishes at choice. Following finished versions are available: blackboard, gold leaf, silver leaf.

Only the smaller option is also available with mirror.

It is possible to create compositions overlapping more elements by means of a specific kit (Art. 0963) to be ordered separately.

Plafonnier / applique pour l'émission de lumière radiale.

Dans la version brute .01, le panneau MDF frontal nécessite

d'une ultérieure finition à choix avec teinte à l'eau ou d'autres vernis.

Autres versions disponibles: tableau noir, feuille d'or, feuille d'argent.

Seulement la petite version est disponible avec miroir.

C'est possible de créer des compositions superposant plusieurs éléments grâce à un kit spécifique (Art 0963) à commander séparément.

Decken- / Wandleuchte für radiale Lichtemission.

In der Rohversion .01 muss die Frontplatte aus MDF mit Wasserfarbe oder anderen Lacken nachbearbeitet werden.

Fertige Versionen: Schultafel, Blattgold, Blattsilber.

Nur die kleinere Option ist mit Spiegel verfügbar.

Mit einem spezifischen Kit (Art. 0963), das separat zu bestellen ist, kann man eine Komposition zu erstellen, die mehrere Elemente überlappt.

Lámpara de techo/pared para emisión de luz radial.

En la versión bruta .01, el panel frontal de MDF requiere

un acabado adicional con pintura al agua u otros barnices a elección.

El producto es también disponible en las versiones siguientes:

pizarra, hoja de oro, hoja de plata.

Solo la opción pequeña también está disponible con espejo.

Mediante un kit específico (Art. 0963), que debe pedirse por separado, es posible crear composiciones superponiendo más elementos.

Настенные и потолочный светильник брющего света.

Блок питания встроен. По запросу есть диммируемые варианты.

После установки необходимо закрасить переднюю панель обычной вододисперсионной краской.

Светильник меньшего диаметра может быть с зеркальной поверхностью, либо с отделкой из сусального золота или сусального серебра.

Подключаясь из одной точки, можно создать разные композиции, накладывающиеся друг на друга благодаря специальному монтажному набору, который заказывается отдельно (арт. 0963).



Q Light
design ABS Studio
2017



.30 Foglia Argento - Silver leaf

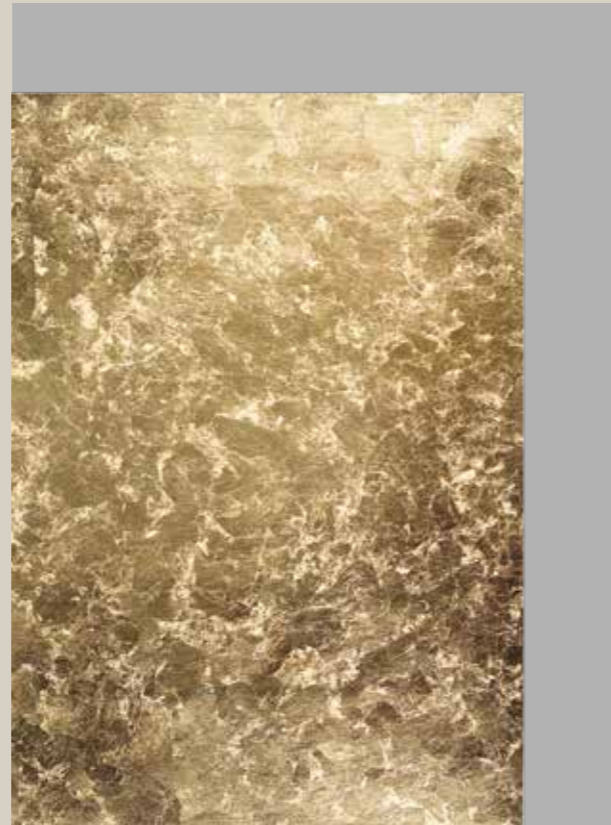

.29 Foglia Oro - Gold leaf



.01 Bianco grezzo da finire
Raw white to be painted



.14 Lavagna - Blackboard



.56 Specchio - Mirror

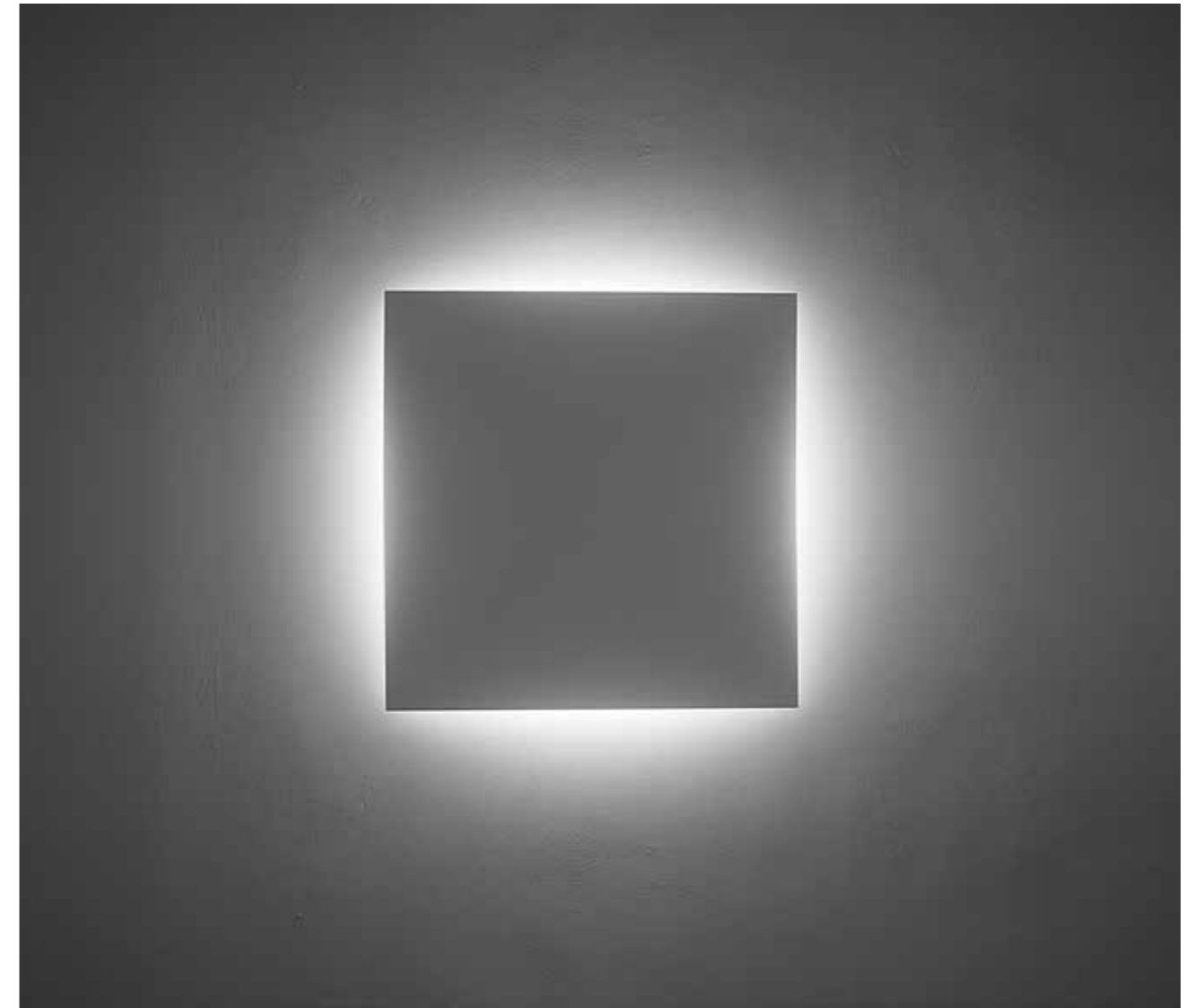

4590	2 kg
.01	Bianco - White
.14	Lavagna - Blackboard
.29	Foglia oro - Gold leaf
.30	Foglia argento - Silver leaf
.56	Specchio - Mirror 3 kg

/W	LED 15W 2000lm 4000K
/WW	LED 15W 1900lm 3000K
/XW	LED 15W 1780lm 2700K

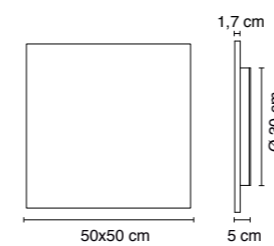

4591	3,2 kg
.01	Bianco - White
.14	Lavagna - Blackboard
.29	Foglia oro - Gold leaf
.30	Foglia argento - Silver leaf

/W	LED 24W 3200lm 4000K
/WW	LED 24W 3040lm 3000K
/XW	LED 24W 2848lm 2700K

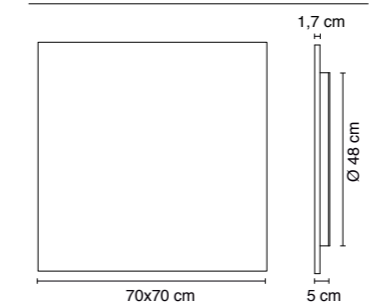

0963	0,3 kg
Distanziale per composizioni multiple Kit for overlapping	
.01	Bianco - White

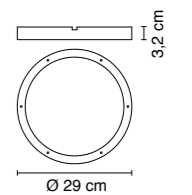

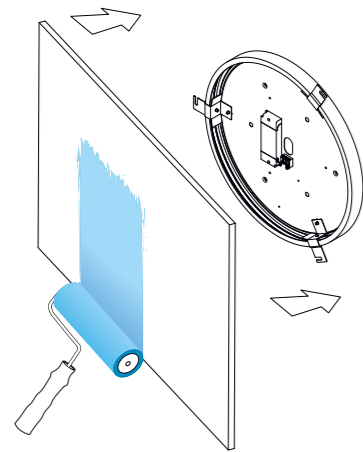
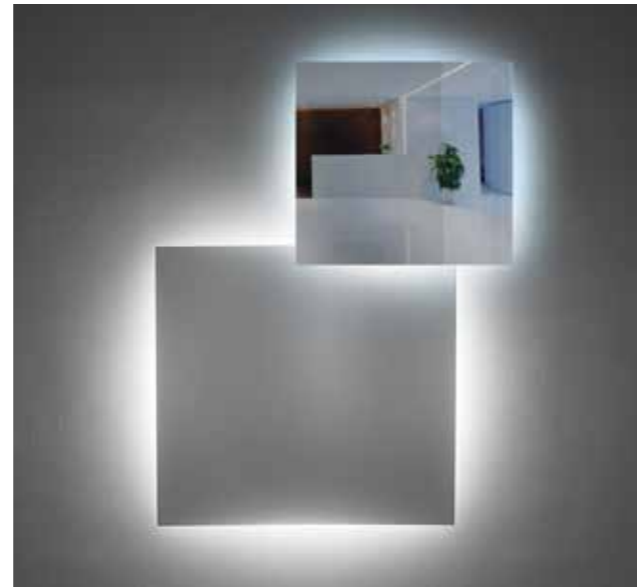

Esempio di installazione singola.
Example of single installation.

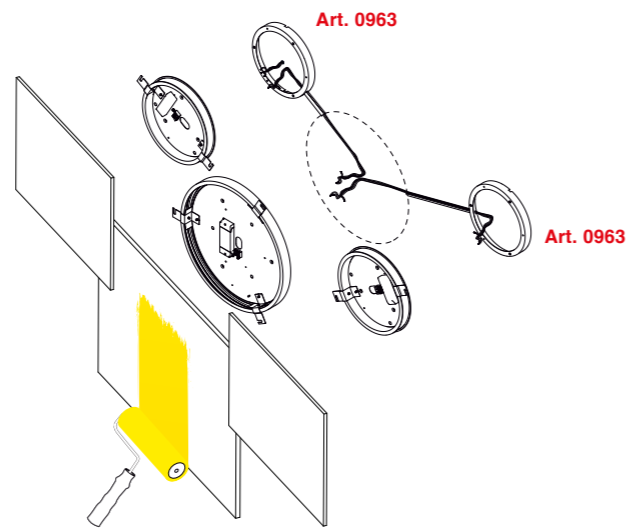

Esempio di installazione multipla con distanziali.
Example of multiple installation with spacers.



**Lampada o sistema d'illuminazione a sospensione componibile.
Il corpo è in alluminio e legno; il primo consente di dissipare il calore mentre il legno in spessore ne caratterizza la forma ad imbuto.**

**La sorgente COB LED è arretrata e schermata da un diffusore opalino.
Questa scelta permette di avere tutti i vantaggi della tecnologia LED garantendo una luce diretta gradevole e non abbagliante.
Il rosone conico contiene il driver.**

Suspension and modular lighting system.
Lamp structure is made of aluminum and wood.

Aluminum is an efficient heat sink whilst the thickness of beech wood highlights the funnel shape of the lamp.

The COB LED light source is recessed and screened by an opal diffuser.

This solution allows to exploit all advantages offered by LED technology granting at the same time a comfortable and non-dazzling direct light.

The conical canopy made of varnished ABS contains the LED driver.

Suspension et système d'éclairage composable suspendu.

Structure en aluminium et bois.

L'aluminium est un efficace dissipateur de chaleur, le bois de hêtre en épaisseur met en évidence la forme de entonnoir de la lampe.

La source de lumière LED COB est reculée et protégée par un diffuseur opale.

Cette solution permet d'exploiter tous les avantages offerts par la technologie LED en ayant au même temps une lumière directe confortable et non-éblouissante.

La rosace conique en ABS verni contient le driver LED.

Pendelleuchte sowie Modulares Beleuchtung-System zur Abhängung.
Die Struktur besteht aus Aluminium und Holz.

Aluminium ist eine effiziente Kühlkörper.

Der dicke Schirm aus Buchenholz unterstreicht die Trichterform der Lampe.

Die COB-LED-Lichtquelle ist zurückgetreten und durch einen opalen Diffusor abgeschirmt. Diese Lösung ermöglicht es, alle Vorteile der LED-Technologie zu nutzen gleichzeitig ein angenehmes und blendfreies direktes Licht zu bekommen.

Die konische Baldachin aus lackiertem ABS enthält den LED-Driver.

Lámpara de suspensión con fuente de luz LED. La estructura de la lámpara está hecha de aluminio y madera.

El aluminio es un buen disipador de calor.

El espesor del madera de haya resalta la forma del embudo de la lámpara.

La fuente de luz LED COB es puesta a tras y protegida por un difusor opal.

Esta solución permite explotar todas las ventajas que ofrece la tecnología LED otorgando al mismo tiempo una luz directa cómoda y no deslumbrante.

El florón cónico de ABS barnizado contiene el driver LED.

Подвесной светодиодный светильник.

Корпус из алюминия и дерева.

Алюминий хорошо отводит тепло, а корпус в форме воронки сделан из дерева (ясень).

Источник света углублен в корпус

и закрыт матовым диффузором.

Благодаря этому высокоэффективный и экономичный светодиод дает отличный направленный свет, но не слепит.

Потолочная розетка конической формы включает в себя драйвер.



Pevera
design Mati
2017



.01 Bianco - White

.02 Nero - Black

.05 Rosso - Red

PEVERA è disponibile bianco opaco con cavo trasparente, nero opaco con cavo nero e rosso rubino con cavo trasparente.
PEVERA is available in matt white with transparent cable, matt black with black cable and ruby red with transparent cable.



1551 0,6 kg

.01 Bianco - White

.02 Nero - Black

.05 Rosso - Red

/W LED 6,5W 865lm 4000K

/WW LED 6,5W 844lm 3000K

/XW LED 6,5W 825lm 2700K

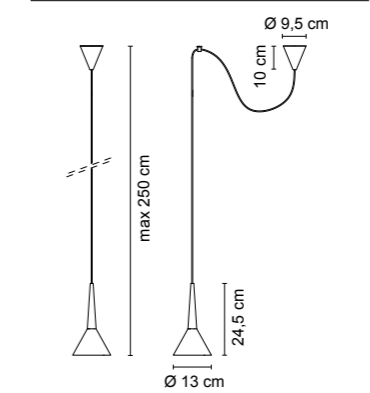

Pevera System 1

design Mati



Esempio d'installazione con presa di corrente comandata (1569.02 + 0968.02).
Example of installation on a switchable socket (1596.02 + 0968.02).



Esempio d'installazione con scatola a parete con interruttore (1568.02 + 0969/S.02).
Example of installation of a wall box with switch (1568.02 + 0969/S.02).

Pevera System 1

design Mati

1568	0,5 kg
.01	Bianco - White
.02	Nero - Black
.05	Rosso - Red
/W	LED 6,5W 865lm 4000K
/WW	LED 6,5W 844lm 3000K
/XW	LED 6,5W 825lm 2700K

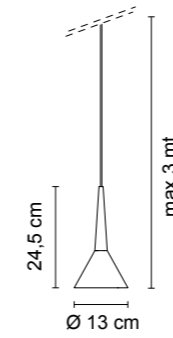

1569	0,7 kg
.01	Bianco - White
.02	Nero - Black
.05	Rosso - Red
/W	LED 6,5W 865lm 4000K
/WW	LED 6,5W 844lm 3000K
/XW	LED 6,5W 825lm 2700K

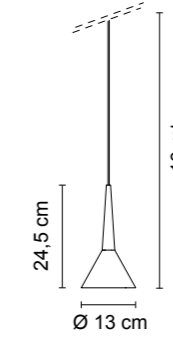

Accessori - Accessories

0968	0,1 kg
Spina a parete con driver integrato + Jack - 1 Pevera Plug in driver + Jack - 1 Pevera	
.02	Nero - Black
50/60Hz 220-240V	



0969	0,2 kg
Rosone senza interruttore con driver integrato - 1 Pevera Canopy with driver (no switch) - 1 Pevera	
.01	Bianco - White
.02	Nero - Black
50/60Hz 220-240V	



Ø 9,3 cm. - h. 3 cm.

0969/S	0,25 kg
Scatola con interruttore con driver integrato - 1 Pevera Wall box with switch - 1 Pevera	
.01	Bianco - White
.02	Nero - Black
50/60Hz 220-240V	



Ø 9,3 cm. - h. 3 cm.

0970

Rosone per cartongesso con alimentatore 1 Pevera Plasterboard ceiling rose with converter 1 Pevera	
.01	Bianco - White
.02	Nero - Black
50/60Hz 220-240V	

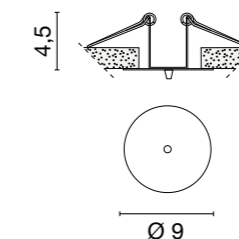

SOLO COLLEGAMENTO IN SERIE - ONLY SERIAL CONNECTION

Pevera System 2

design Mati



Esempio d'installazione (n°2 1568.02 + 0557/2 .02).
Example of installation (2 x 1568.02 + 0557/2 .02).

Pevera System 2

design Mati

1568 0,5 kg

.01	Bianco - White
.02	Nero - Black
.05	Rosso - Red

/W LED 6,5W 865lm 4000K

/WW LED 6,5W 844lm 3000K

/XW LED 6,5W 825lm 2700K

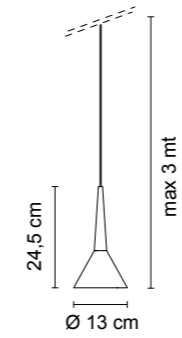

1569 0,7 kg

.01	Bianco - White
.02	Nero - Black
.05	Rosso - Red

/W LED 6,5W 865lm 4000K

/WW LED 6,5W 844lm 3000K

/XW LED 6,5W 825lm 2700K

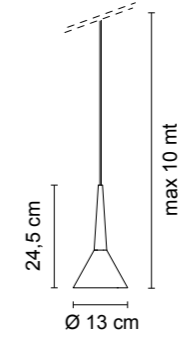

Accessori - Accessories

0557/2 0,5 kg

Rosone completo di alimentatore - **2 Pevera**
Ceiling rose with converter - **2 Pevera**

.01	Bianco - White
.02	Nero - Black

50/60Hz 220-240V

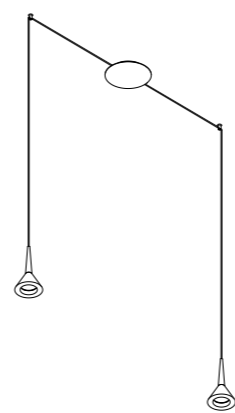
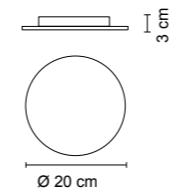

N° 2 1568 + 0557/2

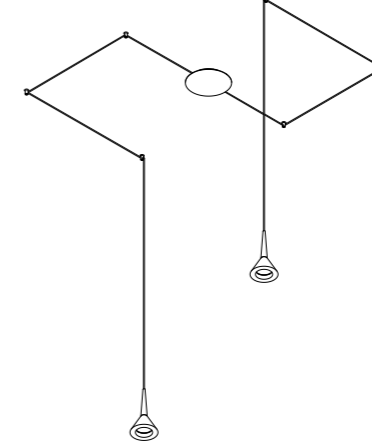

N° 2 1569 + 0557/2

SOLO COLLEGAMENTO IN SERIE - ONLY SERIAL CONNECTION

Pevera System Multiplo

design Mati



Esempio d'installazione radiale con rosone centrale (n°3 1568.01 + 0557/3 .01).
 Example of radial installation with central canopy (3 x 1568.01 + 0557/3 .01).

Pevera System Multiplo

design Mati

1568	0,5 kg
.01	Bianco - White
.02	Nero - Black
.05	Rosso - Red
/W	LED 6,5W 865lm 4000K
/WW	LED 6,5W 844lm 3000K
/XW	LED 6,5W 825lm 2700K

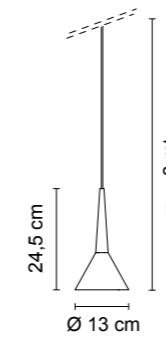

Accessori - Accessories

0557/3	1,7 kg
Rosone completo di alimentatore - 3 Pevera Ceiling rose with converter - 3 Pevera	
.01	Bianco - White
.02	Nero - Black
50/60Hz 220-240V	

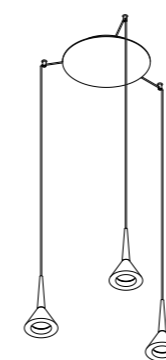
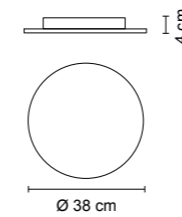

N° 3 1568 + 0557/3

0557/6	1,8 kg
Rosone completo di alimentatore - 4/6 Pevera Ceiling rose with converter - 4/6 Pevera	
.01	Bianco - White
.02	Nero - Black
50/60Hz 220-240V	

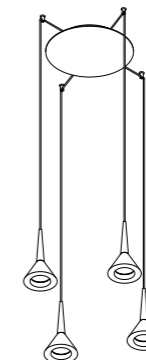
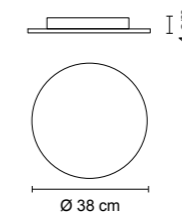

N° 4 1568 + 0557/6

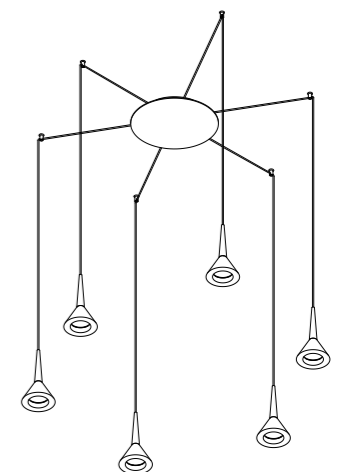

N° 6 1568 + 0557/6

SOLO COLLEGAMENTO IN SERIE - ONLY SERIAL CONNECTION

Pevera System Lineare

design Mati



Esempio d'installazione lineare (n°3 1568.01 + 0556/3 .01).
Example of linear installation (3 x1568.01 + 0556/3 .01).

Pevera System Lineare

design Mati

1568 0,5 kg

.01	Bianco - White
.02	Nero - Black
.05	Rosso - Red

/W LED 6,5W 865lm 4000K

/WW LED 6,5W 844lm 3000K

/XW LED 6,5W 825lm 2700K

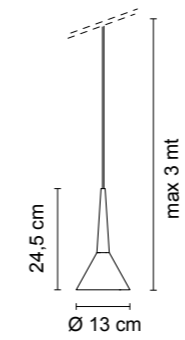
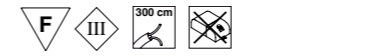

Accessori - Accessories

0556/3 1,2 kg

Rosone completo di alimentatore - **3 Pevera**
Ceiling rose with converter - **3 Pevera**

.01	Bianco - White
.02	Nero - Black
.05	Rosso - Red

50/60Hz 220-240V

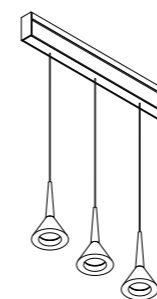
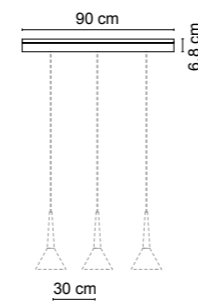

N° 3 1568 + 0556/3 ...

0556/4 1,4 kg

Rosone completo di alimentatore - **4 Pevera**
Ceiling rose with converter - **4 Pevera**

.01	Bianco - White
.02	Nero - Black
.05	Rosso - Red

50/60Hz 220-240V

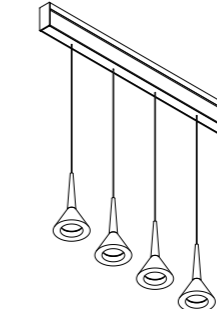
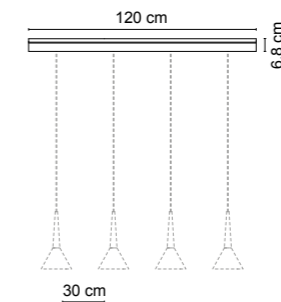

N° 4 1568 + 0556/4 ...

0556/6 1,6 kg

Rosone completo di alimentatore - **6 Pevera**
Ceiling rose with converter - **6 Pevera**

.01	Bianco - White
.02	Nero - Black
.05	Rosso - Red

50/60Hz 220-240V

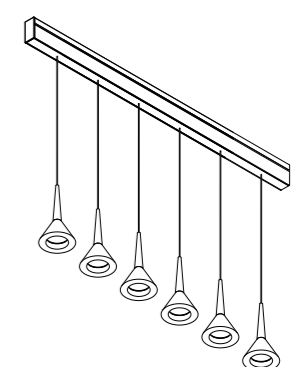
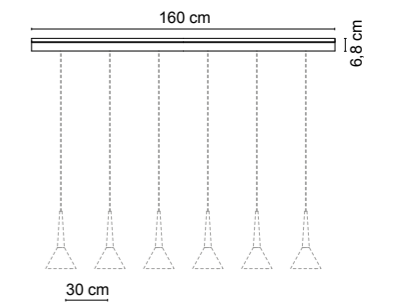

N° 6 1568 + 0556/6 ...



Collezione di lampade a sospensione e parete in alluminio.

La forma è caratterizzata dal taglio laterale che evidenzia la finitura interna. Nelle sospensioni, disponibili in due taglie, il portalampada tradizionale permette la scelta di svariati tipi di lampadina.

Il modello a parete è disponibile solo nella versione piccola con sorgente COB LED e driver integrato.

Collection of suspensions and wall lamps with aluminum shade. The shape is characterized by the particular side cut that put into evidence the internal finish. Suspensions are available in two sizes with screw socket that allows the choice among a wide variety of bulbs.

The wall sconce is only available in the smaller dimension with an integrated COB LED and driver.

Collection de suspensions et appliques avec abat-jour en aluminium.

La forme est caractérisée par la particulière coupe latérale qui met en évidence la finition interne.

Les suspensions sont disponibles dans deux tailles avec douille à vis qui permet la choix parmi une grande variété d'ampoules.

L'applique murale est disponible uniquement dans la version petite avec COB LED et driver intégrés.

Serie von Hängeleuchten und Wandleuchten mit Aluminiumschirm. Die Form ist durch den besonderen Seitenschnitt gekennzeichnet, der das innere Finish sichtbar macht. Die Pendelleuchte sind in zwei Größen erhältlich.

Der traditionelle Schraubfassung ermöglicht die Glühlampen. Die Wandleuchte ist nur in der kleineren Dimension mit integrierter COB-LED und Driver erhältlich.

Colección de lámparas de pared colgantes de aluminio.

La forma se caracteriza por un corte lateral que hace resaltar el acabado interno. En las suspensiones, disponibles en dos tamaños, el portalámparas tradicional permite la elección de varios tipos de bombillas.

El modelo de pared solo está disponible en la versión pequeña con fuente COB LED y driver integrado.

Коллекция подвесных и настенных светильников с корпусом из алюминия. Вырез особой формы позволяет видеть отделку внутренней поверхности. Подвесные светильники в двух размерах. Выбор цоколей позволяет использовать разные источники света. Настенная модель есть только в маленьком варианте высотой 31 см. Светодиодная плата COB LED и драйвер встроены.



Slice
design L. Ramael
2017

Slice
design L. Ramael



.05.01 Rosso / interno bianco
Out Red / in white



.02.29 Nero / interno foglia oro
Out black / in gold leaf



.01 Bianco - White



.02.01 Nero / interno bianco
Out black / in white

Slice
design L. Ramael



1552

0,50kg

- .01** Bianco - White
- .02.01** Nero / interno bianco - Out black / in white
- .02.29** Nero / interno foglia oro - Out black / in gold leaf
- .05.01** Rosso / interno bianco - Out red / in white

6W E14 LED (cod. 0105/mini)

42W E14 ECO

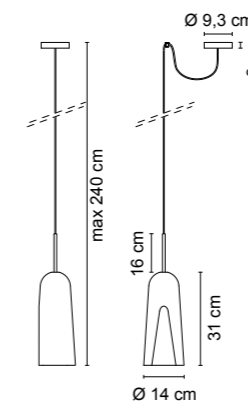

1553

0,75 kg

- .01** Bianco - White
- .02.01** Nero / interno bianco - Out black / in white
- .02.29** Nero / interno foglia oro - Out black / in gold leaf
- .05.01** Rosso / interno bianco - Out red / in white

12W E27 LED (cod. 0105/12)

16W E27 PAR30 LED (cod. 0106)

52W E27 ECO

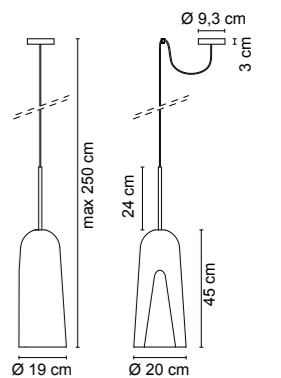

Slice
design L. Ramael



.01 Bianco - White



.02.01 Nero / interno bianco
Out black / in white

Slice
design L. Ramael



4586

0,60kg

.01 Bianco - White

.02.01 Nero / interno bianco - Out black / in white

/W LED 9,8W 1210lm 4000K

/WW LED 9,8W 1111lm 3000K

/XW LED 9,8W 1085lm 2700K

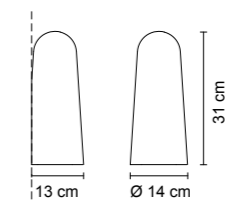

Slice
design L. Ramael



Slice
design L. Ramael



Lampada a sospensione con paralume circolare in tessuto e PVC autoestinguente. Struttura in alluminio con diffusore in policarbonato opalino. Versioni dimmerabili disponibili su richiesta.

Suspension lamps with shade in self-extinguishing fabric and PVC. Internal aluminum frame with opal polycarbonate diffuser. Dimmable options available upon request.

Série de suspensions avec abat-jour en tissu auto-extinguible et PVC. Cadre interne en aluminium avec diffuseur en polycarbonate opale. Options dimmable disponibles sur demande.

Pendelleuchte mit Schirm aus selbstverlöschendem Gewebe und PVC. Innenstruktur aus Aluminium mit Diffusor aus opalem Polycarbonat. Dimmbare Optionen auf Anfrage erhältlich.

Serie de colgantes con pantalla en tejido autoextinguible y PVC. Perfil interno de aluminio con difusor de policarbonato opal. Opciones regulables disponibles bajo pedido.

Подвесной светильник с круглым абажуром из негорючей ткани и поливинилхлорида. Структура из алюминия, диффузор из матового поликарбоната. По запросу есть диммируемые варианты.



Radar
design ABS Studio
2018



.02.21 Nero / interno dorato lucido
Out black / in satin gold



.01 Bianco - White



.02.01 Nero / interno bianco
Out black / in white

1570	2,50 kg
.01	Bianco - White
.02.01	Nero / interno bianco - Out black / in white
.02.21	Nero / interno dorato lucido - Out black / in satin gold
/W	LED 37,5W 5000lm 4000K CRI>90
/WW	LED 37,5W 4958lm 3000K CRI>90
/XW	LED 37,5W 4479lm 2700K CRI>90

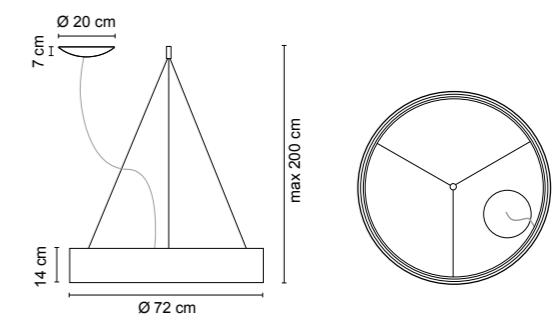

1571	3 kg
.01	Bianco - White
.02.01	Nero / interno bianco - Out black / in white
.02.21	Nero / interno dorato lucido - Out black / in satin gold
/W	LED 54W 7200lm 4000K CRI>90
/WW	LED 54W 7140lm 3000K CRI>90
/XW	LED 54W 6450lm 2700K CRI>90

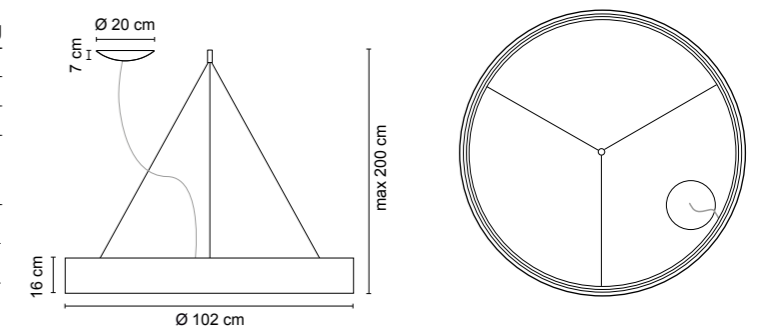



Lampade da soffitto/parete e sospensioni a luce diffusa.
La semisfera in metacrilato trasparente è ricoperta da un elegante tessuto bianco a rete in lycra che conferisce gradevolezza e uniformità alla luce.
La versione soffitto/parete può essere installata in composizioni multiple grazie alla predisposizione per l'interconnessione.

Suspension and ceiling/wall lamps for diffused light. The hemispherical transparent diffuser is wrapped in an elegant white Lycra mesh providing a pleasant and uniform light. Ceiling/wall options can be installed in groups thanks to the predisposition for interconnection.

Suspension et plafonniers/appliques pour lumière diffuse.
Le diffuseur transparent hémisphérique est enveloppé dans une élégante maille en Lycra blanc délivrant une lumière agréable et uniforme.
Les options plafond / mur peuvent être installées en groupe grâce à la prédisposition pour l'interconnexion.

Pendelleuchten und Decken- / Wandleuchten für diffuses Licht.
Der halbkugelförmige Diffusor ist in einem eleganten Weiß Lycra Netz eingewickelt und sorgt für ein angenehmes und gleichmäßiges Licht. Die Prädisposition für Zwischenverdrahtung der Decken-Wandleuchten ermöglicht die Montage von mehreren Leuchten auf eine einzelne Stromauslass.

Suspensión y lámparas de techo / pared para luz difusa.
El difusor hemisférico transparente está envuelto en una elegante Malla de lycra blanca por una luz agradable y uniforme.
Las opciones de techo / pared se pueden instalar en grupos gracias a la predisposición para interconexión.

Настенный или потолочный, а также подвесной светильник рассеянного света. Полусфера из прозрачного метакрилата, покрытого тонкой элегантной сеточкой из белой ткани из полиэстера и ликры дает эффект приятного ровного света. Потолочные и настенные светильники могут устанавливаться поодиночке или композициями из нескольких штук.



Fabric
design N. Dewez
2017

Fabric
design N. Dewez



Fabric
design N. Dewez



1555 1,9 kg
.01 Bianco - White

/WW LED 24W 1900lm 3000K
F

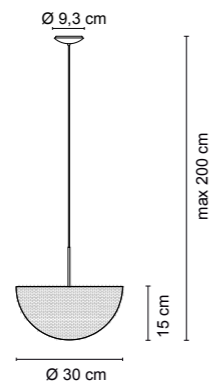

1556 2,5 kg
.01 Bianco - White

/WW LED 36W 3000lm 3000K
F

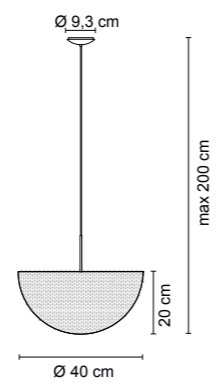

5563 1,6 kg
.01 Bianco - White

/WW LED 24W 1900lm 3000K
F

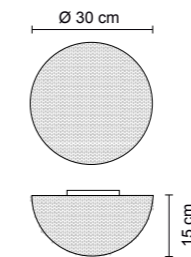

5564 2,2 kg
.01 Bianco - White

/WW LED 36W 3000lm 3000K
F

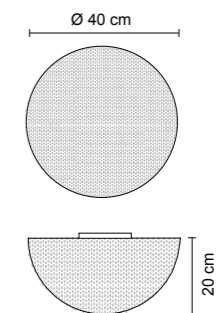

Fabric
design N. Dewez



Fabric
design N. Dewez

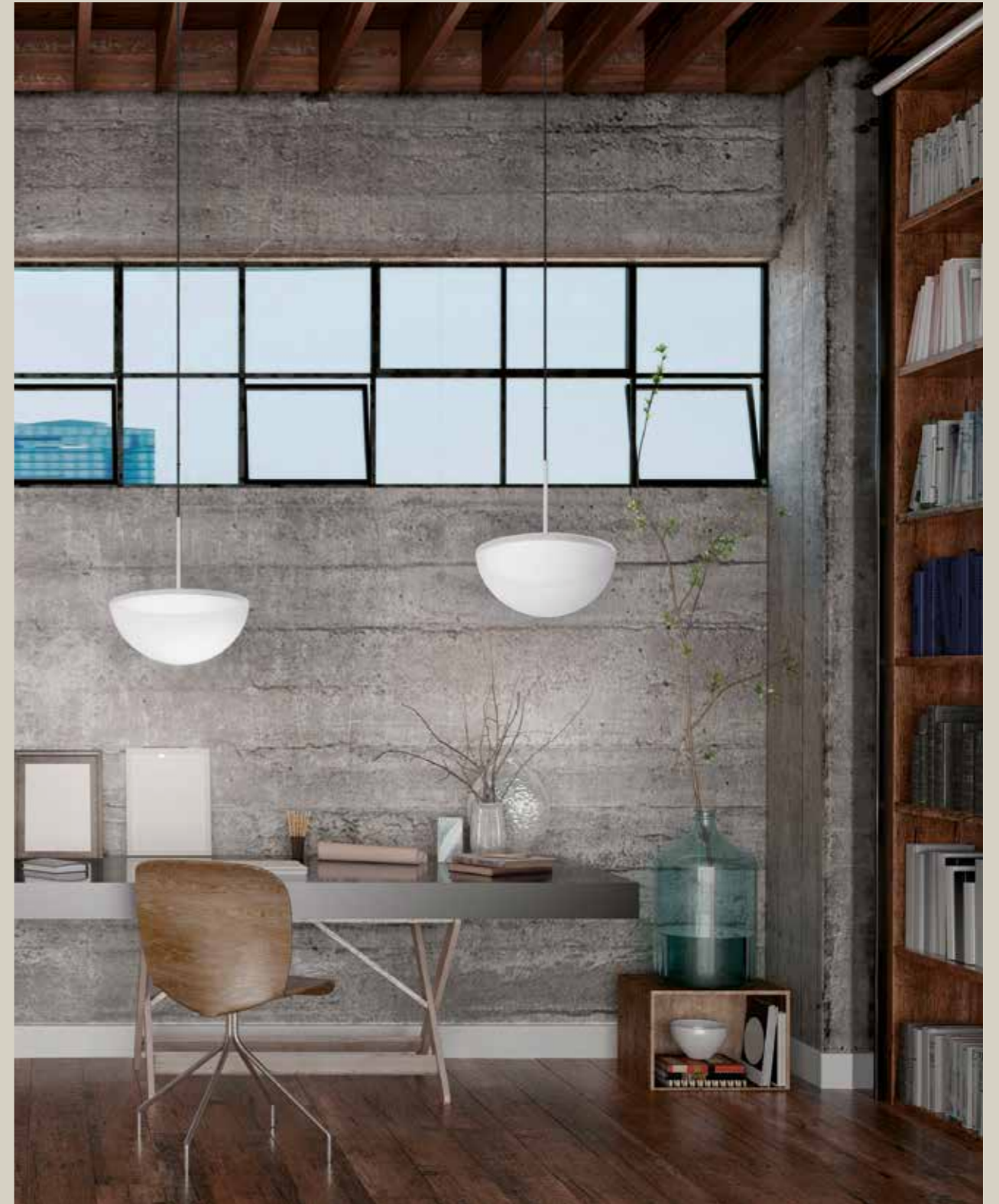

Lampada a sospensione con paralume a pieghe in tessuto pongé.
Struttura in alluminio con diffusore in policarbonato opalino.
Paralumi disponibili in bianco, avorio e marrone (altri colori disponibili a richiesta). Versioni dimmerabili disponibili su richiesta.

Suspension lamps with plissé shade in pongé cloth. Internal aluminum frame with opal polycarbonate diffuser. Shade available in white, ivory and brown color (other finishes available upon request). Dimmable options available upon request.

Série de suspensions avec abat-jour plissé en tissu pongé. Structure interne en aluminium avec diffuseur en polycarbonate opale. Abat-jour disponible en blanc, Ivoire et marron (autres finitions disponibles sur requête). Options dimmable disponibles sur demande.

Pendelleuchte mit gefaltet Lampenschirm aus Gewebe Pongé.
Innenstruktur aus Aluminium mit Diffusor aus opalem Polycarbonat.
Schirm in Weiß, Elfenbein oder braunfarbig (mehrere Farben auf Anfrage).
Dimmbare Optionen erhältlich auf Anfrage.

Serie de colgantes con pantalla en tejido pliado pongé.
Perfil interno de aluminio con difusor de policarbonato opal.
Pantalla disponible en blanco, marfil, marrón (otros colores bajo pedido).
Opciones regulables disponibles bajo pedido.

Подвесной светильник с плиссированным абажуром из ткани pongé'. Структура из алюминия, диффузор из матового поликарбоната. Абажуры белые, цвета слоновой кости, коричневые (возможны и другие цвета по запросу).
Имеются диммируемые варианты.



Charme
design ABS Studio
2018



.35 Sabbia - Sand

.42 Tortora - Dove Grey



.01 Bianco - White

1593		2,50 kg
.01	Bianco - White	
.35	Sabbia - Sand	
.42	Tortora - Dove Grey	
/W	LED 37,5W 5000lm 4000K CRI>90	
/WW	LED 37,5W 4958lm 3000K CRI>90	
/XW	LED 37,5W 4479lm 2700K CRI>90	

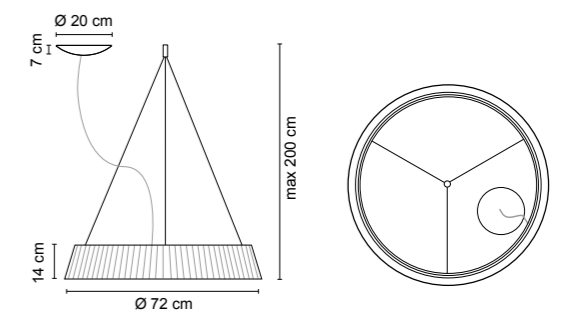



Collezione di lampade a LED.
La versione a sospensione si completa con rosoni, cavi ed accessori che personalizzano il progetto.
Questa famiglia di prodotti comprende inoltre uno spot incasso orientabile presentato nel nostro catalogo tecnico.

Lamps LED collection.
For the suspended solutions a range of ceiling roses, cables and accessories is available to customize your system. This product range is completed by an adjustable recessed spot presented in our technical catalogue.

Série de spots orientables disponibles en version plafond/mur, suspension ou lampadaire.
Pour les solutions suspendues, une gamme de rosaces, de câbles et d'accessoires est disponible pour personnaliser votre système.
Cette gamme de produits est complétée par un spot encastrable réglable présenté dans notre catalogue technique.

Serie von schwenkbarer Lichtstrahler erhältlich als Decken-/Wand-, Pendel- oder Stehversion.
Für die Pendelversion steht eine Reihe von Deckenrosetten, Kabeln und Zubehör zur Verfügung, um Ihr System individuell anzupassen. Diese Produktreihe wird durch eine verstellbare Einbauleuchte ergänzt, die in unserem technischen Katalog vorgestellt ist.

Serie de spot disponibles en version techo/pared, suspensión o lámpara de pie.
Para las soluciones suspendidas, una gama de florones, cables y accesorios está disponible para personalizar su sistema. Esta gama de productos se completa con uno spot empotrable ajustable presentado en nuestro catálogo técnico.

Серия настенных, подвесных и напольных ориентируемых спотов с технологией COB LED.
Подвесной светильник в комплекте с потолочной розеткой, кабелем и аксессуарами для персонализации системы. В этой серии также есть встроенный направляемый спот, который можно найти в нашем техническом каталоге.



Newton
design ABS Studio
2016



Ottica standard: 38°. A richiesta: 24° o 58°.
Standard beam angle: 38°. Upon request: 24° or 58°.



1590		0,80kg
.02	Nero - Black	
.25	Dorato satinato - Satin gold	
.32	Nickel satinato - Nickel mat	

LED cod.	OPTION	lm/LED color
/W		LED 6,1W CRI>80 975lm 4000K
/W/ST	Vetro satinato - Satin glass	LED 6,1W CRI>80 975lm 4000K
/WW		LED 6,1W CRI>80 939lm 3000K
/WW/ST	Vetro satinato - Satin glass	LED 6,1W CRI>80 939lm 3000K
/XW		LED 6,1W CRI>80 896lm 2700K
/XW/ST	Vetro satinato - Satin glass	LED 6,1W CRI>80 896lm 2700K

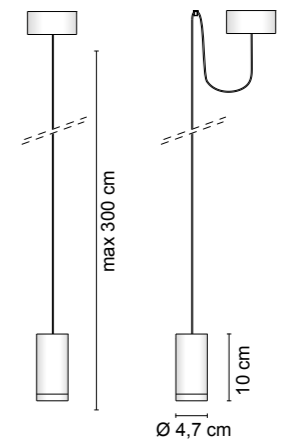

Newton System1

design ABS Studio



0970

Rosone per cartongesso con alimentatore
1 Newton
 Plasterboard ceiling rose with converter
1 Newton

- .01** Bianco - White
- .02** Nero - Black

50/60Hz 220-240V



7,5 cm.

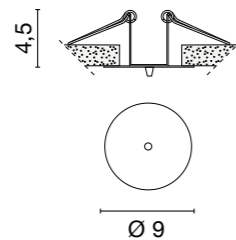

SOLO COLLEGAMENTO IN SERIE - ONLY SERIAL CONNECTION

Newton System 1

design ABS Studio

1591

0,50kg

- .02** Nero - Black
- .25** Dorato satinato - Satin gold
- .32** Nickel satinato - Nickel mat

LED cod. OPTION	lm/LED color
/W	LED 6,1W 17,3V 350mA CRI>80 975lm 4000K
/W/ST Vetro satinato - Satin glass	LED 6,1W 17,3V 350mA CRI>80 975lm 4000K
/WW	LED 6,1W 17,3V 350mA CRI>80 939lm 3000K
/WW/ST Vetro satinato - Satin glass	LED 6,1W 17,3V 350mA CRI>80 939lm 3000K
/XW	LED 6,1W 17,3V 350mA CRI>80 896lm 2700K
/XW/ST Vetro satinato - Satin glass	LED 6,1W 17,3V 350mA CRI>80 896lm 2700K

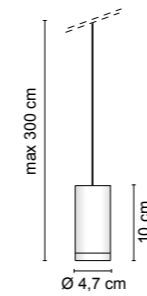

.02 Nero - Black



.32 Nickel - Nickel

1592

0,70kg

- .02** Nero - Black
- .25** Dorato satinato - Satin gold
- .32** Nickel satinato - Nickel mat

LED cod. OPTION	lm/LED color
/W	LED 6,1W 17,3V 350mA CRI>80 975lm 4000K
/W/ST Vetro satinato - Satin glass	LED 6,1W 17,3V 350mA CRI>80 975lm 4000K
/WW	LED 6,1W 17,3V 350mA CRI>80 939lm 3000K
/WW/ST Vetro satinato - Satin glass	LED 6,1W 17,3V 350mA CRI>80 939lm 3000K
/XW	LED 6,1W 17,3V 350mA CRI>80 896lm 2700K
/XW/ST Vetro satinato - Satin glass	LED 6,1W 17,3V 350mA CRI>80 896lm 2700K

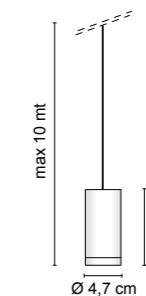

.25 Dorato satinato - Satin Gold

Accessori - Accessories

0968

0,1 kg

Spina a parete con driver integrato + Jack - **1 Newton**
 Plug in driver
 + Jack - **1 Newton**

- .02** Nero - Black

50/60Hz 220-240V



0969

0,2 kg

Rosone senza interruttore con driver integrato - **1 Newton**
 Canopy with driver
 (no switch) - **1 Newton**

- .01** Bianco - White
- .02** Nero - Black

50/60Hz 220-240V



Ø 9,3 cm. - h. 3 cm.

0969/S

0,25 kg

Scatola con interruttore con driver integrato - **1 Newton**
 Wall box
 with switch - **1 Newton**

- .01** Bianco - White
- .02** Nero - Black

50/60Hz 220-240V



Ø 9,3 cm. - h. 3 cm.



Newton System 2

design ABS Studio

1591 0,50kg

.02	Nero - Black
.25	Dorato satinato - Satin gold
.32	Nickel satinato - Nickel mat

LED cod. OPTION **lm/LED color**

/W LED 6,1W 17,3V 350mA CRI>80 975lm 4000K

/W/ST Vetro satinato - Satin glass LED 6,1W 17,3V 350mA CRI>80 975lm 4000K

/WW LED 6,1W 17,3V 350mA CRI>80 939lm 3000K

/WW/ST Vetro satinato - Satin glass LED 6,1W 17,3V 350mA CRI>80 939lm 3000K

/XW LED 6,1W 17,3V 350mA CRI>80 896lm 2700K

/XW/ST Vetro satinato - Satin glass LED 6,1W 17,3V 350mA CRI>80 896lm 2700K

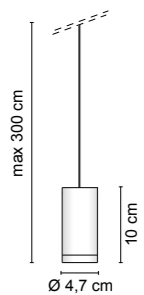
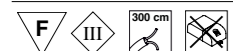

.02 Nero - Black



.32 Nickel - Nickel

1592 0,70kg

.02	Nero - Black
.25	Dorato satinato - Satin gold
.32	Nickel satinato - Nickel mat

LED cod. OPTION **lm/LED color**

/W LED 6,1W 17,3V 350mA CRI>80 975lm 4000K

/W/ST Vetro satinato - Satin glass LED 6,1W 17,3V 350mA CRI>80 975lm 4000K

/WW LED 6,1W 17,3V 350mA CRI>80 939lm 3000K

/WW/ST Vetro satinato - Satin glass LED 6,1W 17,3V 350mA CRI>80 939lm 3000K

/XW LED 6,1W 17,3V 350mA CRI>80 896lm 2700K

/XW/ST Vetro satinato - Satin glass LED 6,1W 17,3V 350mA CRI>80 896lm 2700K

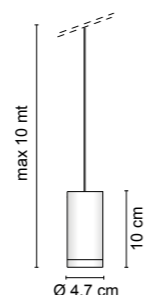
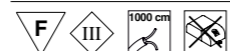

.25 Dorato satinato - Satin Gold

Newton System Multiplo

design ABS Studio

1591 0,50kg

.02	Nero - Black
.25	Dorato satinato - Satin gold
.32	Nickel satinato - Nickel mat

LED cod. OPTION **lm/LED color**

/W LED 6,1W 17,3V 350mA CRI>80 975lm 4000K

/W/ST Vetro satinato - Satin glass LED 6,1W 17,3V 350mA CRI>80 975lm 4000K

/WW LED 6,1W 17,3V 350mA CRI>80 939lm 3000K

/WW/ST Vetro satinato - Satin glass LED 6,1W 17,3V 350mA CRI>80 939lm 3000K

/XW LED 6,1W 17,3V 350mA CRI>80 896lm 2700K

/XW/ST Vetro satinato - Satin glass LED 6,1W 17,3V 350mA CRI>80 896lm 2700K

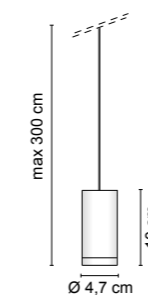

.02 Nero - Black



.32 Nickel - Nickel



.25 Dorato satinato - Satin Gold

Accessori - Accessories

0557/3 1,7 kg

Rosone completo di alimentatore - **3 Newton**
Ceiling rose with converter - **3 Newton**

.01	Bianco - White
.02	Nero - Black

50/60Hz 220-240V



0557/6 1,8 kg

Rosone completo di alimentatore - **4/6 Newton**
Ceiling rose with converter - **4/6 Newton**

.01	Bianco - White
.02	Nero - Black

50/60Hz 220-240V

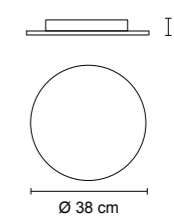

Accessori - Accessories

0557/2 0,5 kg

Rosone completo di alimentatore - **2 Newton**
Ceiling rose with converter - **2 Newton**

.01	Bianco - White
.02	Nero - Black

50/60Hz 220-240V

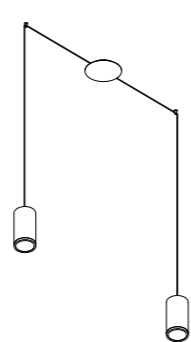
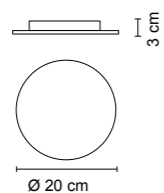

N° 2 1591 + 0557/2

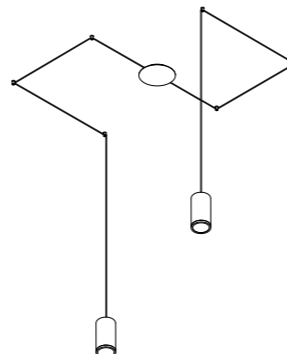

N° 2 1592 + 0557/2

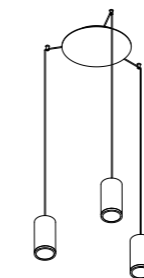

N° 3 1591/1592 + 0557/3

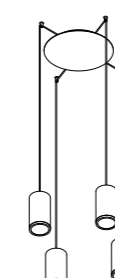

N° 4 1591/1592 + 0557/6

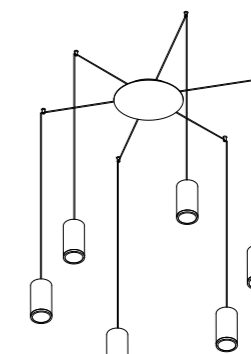

N° 6 1591/1592 + 0557/6

SOLO COLLEGAMENTO IN SERIE - ONLY SERIAL CONNECTION

SOLO COLLEGAMENTO IN SERIE - ONLY SERIAL CONNECTION

Newton System

design ABS Studio



Esempio d'installazione con rosone con driver integrato (1592.02 + 0969.02).
Example of installation with canopy with driver (1592.02 + 0969.02).



Esempio d'installazione con rosone con driver integrato (1591.02 + 0557/2).
Example of installation with canopy with driver (1591.02 + 0557/2).



Esempio d'installazione con rosone con driver integrato (1591.02 + 0557/3).
Example of installation with canopy with driver (1591.02 + 0557/3).

Newton System Lineare

design ABS Studio

1591		0,50kg
.02	Nero - Black	
.25	Dorato satinato - Satin gold	
.32	Nickel satinato - Nickel mat	

LED cod.	OPTION	lm/LED color
/W		LED 6,1W 17,3V 350mA CRI>80 975lm 4000K
/W/ST	Vetro satinato - Satin glass	LED 6,1W 17,3V 350mA CRI>80 975lm 4000K
/WW		LED 6,1W 17,3V 350mA CRI>80 939lm 3000K
/WW/ST	Vetro satinato - Satin glass	LED 6,1W 17,3V 350mA CRI>80 939lm 3000K
/XW		LED 6,1W 17,3V 350mA CRI>80 896lm 2700K
/XW/ST	Vetro satinato - Satin glass	LED 6,1W 17,3V 350mA CRI>80 896lm 2700K

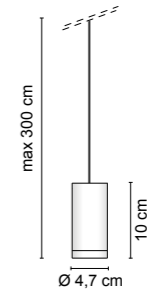

Accessori - Accessories

0556/3	1,2 kg	0556/4	1,4 kg	0556/6	1,6 kg
Rosone completo di alimentatore - 3 Newton Ceiling rose with converter - 3 Newton		Rosone completo di alimentatore - 4 Newton Ceiling rose with converter - 4 Newton		Rosone completo di alimentatore - 6 Newton Ceiling rose with converter - 6 Newton	
.01	Bianco - White	.01	Bianco - White	.01	Bianco - White
.02	Nero - Black	.02	Nero - Black	.02	Nero - Black

50/60Hz 220-240V

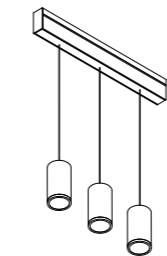
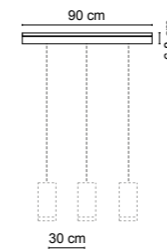

N° 3 1591 + 0556/3 ...

50/60Hz 220-240V

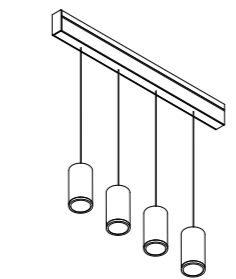
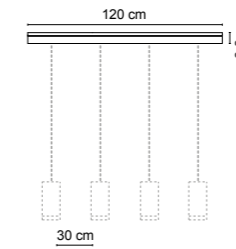

N° 4 1591 + 0556/4 ...

50/60Hz 220-240V

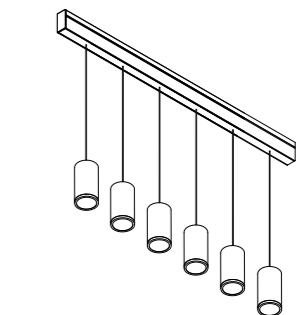
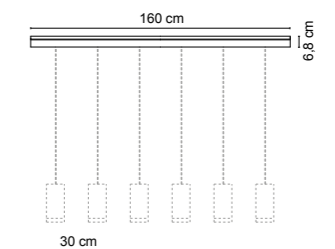

N° 6 1591 + 0556/6 ...



3510 9,5 kg

.01 Bianco - White

.02 Nero - Black

LED cod.	Beam angle/OPTION	lm	LED color
/W	/24 /38 /58	LED 4x8,9W 18,4V 500mA	1353lm 4000K
/W/ST	Vetro satinato - Satin glass	LED 4x8,9W 18,4V 500mA	1353lm 4000K
/WW	/24 /38 /58	LED 4x8,9W 18,4V 500mA	1303lm 3000K
/WW/ST	Vetro satinato - Satin glass	LED 4x8,9W 18,4V 500mA	1303lm 3000K
/XW	/24 /38 /58	LED 4x8,9W 18,4V 500mA	1244lm 2700K
/XW/ST	Vetro satinato - Satin glass	LED 4x8,9W 18,4V 500mA	1244lm 2700K

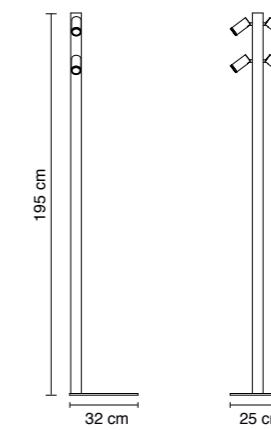



4562		0,6 kg
.01	Bianco - White	
.02	Nero - Black	
.31	Cromo - Chromed	

LED cod.	Beam angle/OPTION		lm	LED color
/W	/24 /38 /58	LED 8,9W 18,4V 500mA	1353lm	4000K
/W/ST	Vetro satinato - Satin glass	LED 8,9W 18,4V 500mA	1353lm	4000K
/WW	/24 /38 /58	LED 8,9W 18,4V 500mA	1303lm	3000K
/WW/ST	Vetro satinato - Satin glass	LED 8,9W 18,4V 500mA	1303lm	3000K
/XW	/24 /38 /58	LED 8,9W 18,4V 500mA	1244lm	2700K
/XW/ST	Vetro satinato - Satin glass	LED 8,9W 18,4V 500mA	1244lm	2700K

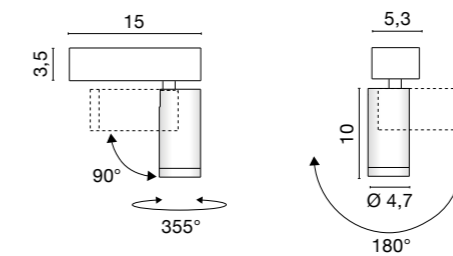

Lampade a sospensione realizzate in alluminio. Un design innovativo che, rivisitando forme classiche, inventa per esse nuove funzioni ed effetti. L'insolito posizionamento delle sorgenti LED nella parte bassa dell'apparecchio crea riflessi e proiezioni di luce inattese. Disponibile nelle finiture: Bianco, Nero/ foglia oro. Rosoni o piastre con alimentatore incluso da ordinare separatamente.

Pendant lamps made of aluminium. An innovative design that revisits classic shapes inventing for them new functions and effects. The unusual positioning of the LED sources in the lower part of the unit creates unexpected light reflections and projections. Available in white or black/gold leaf. Canopy or fixing plates including converter are sold separately.

Suspension en aluminium. Un design innovant qui, revisitant des formes classiques, invente de nouvelles fonctions et effets. Le positionnement inhabituelle des sources LED dans la partie inférieure de l'appareil crée des réflexions et des projections de lumière inattendus. Disponible en blanc ou noir/feuille d'or. Rosace ou plaque de fixation avec convertisseur inclus à commander séparément.

Pendelleuchte aus Metall. Ein innovatives Design, das klassische Linien aufgreift und sie mit neuen Funktionen und Effekten verbindet. Die außergewöhnliche Positionierung der LEDs im unteren Teil des schafft unerwartete Lichtreflexionen und Projektionen. Erhältlich in weiß oder schwarz/Blattgold. Baldachin oder montageplatte inklusive Konverter separat bestellen.

Colgante de metal. Un diseño innovador que revisita formas clásicas inventando por esas nuevas funciones y efectos. El posicionamiento inusual de las fuentes de luz LED en la parte baja de la unidad crea reflejos de luz y proyecciones inesperadas. Disponible en acabado blanco o negro/hoja de oro. Baldaquin o placas de anclaje con convertidor incluido a pedir por separado.

Серия подвесных светильников из металла. Инновационный дизайн придает классическим формам новые функции и эффекты. Необычное расположение светодиодов в нижней части светильника создает неожиданные отражения и проекции света. Цвета: белый или черный/золотой лист. Конвертер включен.



Spirits
design S. Cornelissen
2015



Esempio d'installazione con rosone con driver integrato (1535.01/WW + 1535.01.28/WW + 0952.01).
Example of installation with canopy with driver (1535.01/WW + 1535.01.28/WW + 0952.01).

1535

1 kg

- .01** Bianco - White
- .01.30** Bianco / Foglia argento - Out white/ in silver leaf
- .02.29** Nero / Foglia oro - Out black / in gold leaf

/WW LED 53V 250mA 13,2W 1900lm 3000K

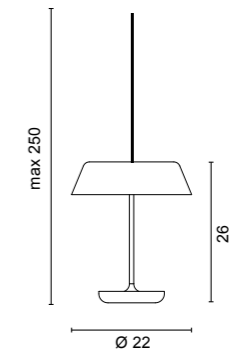

.01.28 Bianco / foglia argento
Out white / in silver leaf



.01 Bianco - White



.02.29 Nero / foglia oro
Out black / in gold leaf

0951

1 kg

Rosone completo di alimentatore
- 1 Spirits
Ceiling rose with converter
- 1 Spirits

- .01** Bianco - White
- .02** Nero - Black

50/60Hz 220-240V

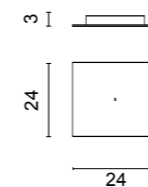

0952

2 kg

Rosone completo di alimentatore
- 2 Spirits
Ceiling rose with converter
- 2 Spirits

- .01** Bianco - White
- .02** Nero - Black

50/60Hz 220-240V

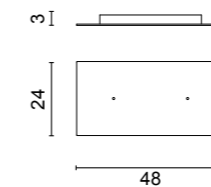

0953

3,8 kg

Rosone completo di alimentatore
- 4 Spirits
Ceiling rose with converter
- 4 Spirits

- .01** Bianco - White
- .02** Nero - Black

50/60Hz 220-240V

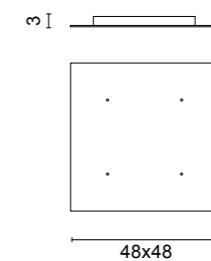

0954

0,2 kg

Rosone per cartongesso con alimentatore
- 1 Spirits
Plasterboard ceiling rose with converter
- 1 Spirits

- .01** Bianco - White

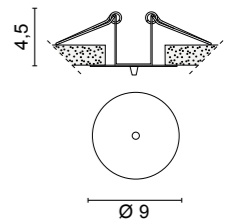

SOLO COLLEGAMENTO IN SERIE - ONLY SERIAL CONNECTION



Serie di lampade a parete di grandi dimensioni per luce radente.
I corpi, realizzati in alluminio, utilizzano come sorgente potenti circuiti LED lineari di ultima generazione. Converter integrato. Disponibili in bianco o nero.

Series of large sized wall lamps for grazing light. The aluminum structures are fitted with powerful latest generation linear LED circuits. Integrated converter. Available in white or black finishes.

Série d'appliques de grands dimensions pour lumière rasante. Corps en aluminium équipé de puissants circuits linéaires LED de dernière génération. Convertisseur intégré. Disponible en blanc ou noir finitions.

Serie großer Wandleuchten für Streiflicht. Die Strukturen aus Aluminium sind mit leistungsstarken linearen LED Modulen der neuesten Generation ausgestattet. Integrierter Converter. Erhältlich in weiss oder schwarz Ausführungen.

Serie de lámparas de pared de grande tamaño por luz rasante. Las estructuras de aluminio están equipadas con potentes circuitos lineares LED de última generación. Convertidor integrado. Disponible en blanco o negro acabados.

Серия больших настенных светильников с брещим лучом. Корпус из алюминия. Мощные светодиодные линейные светодиоды. Конвертер включен. Цвета: белый или черный.

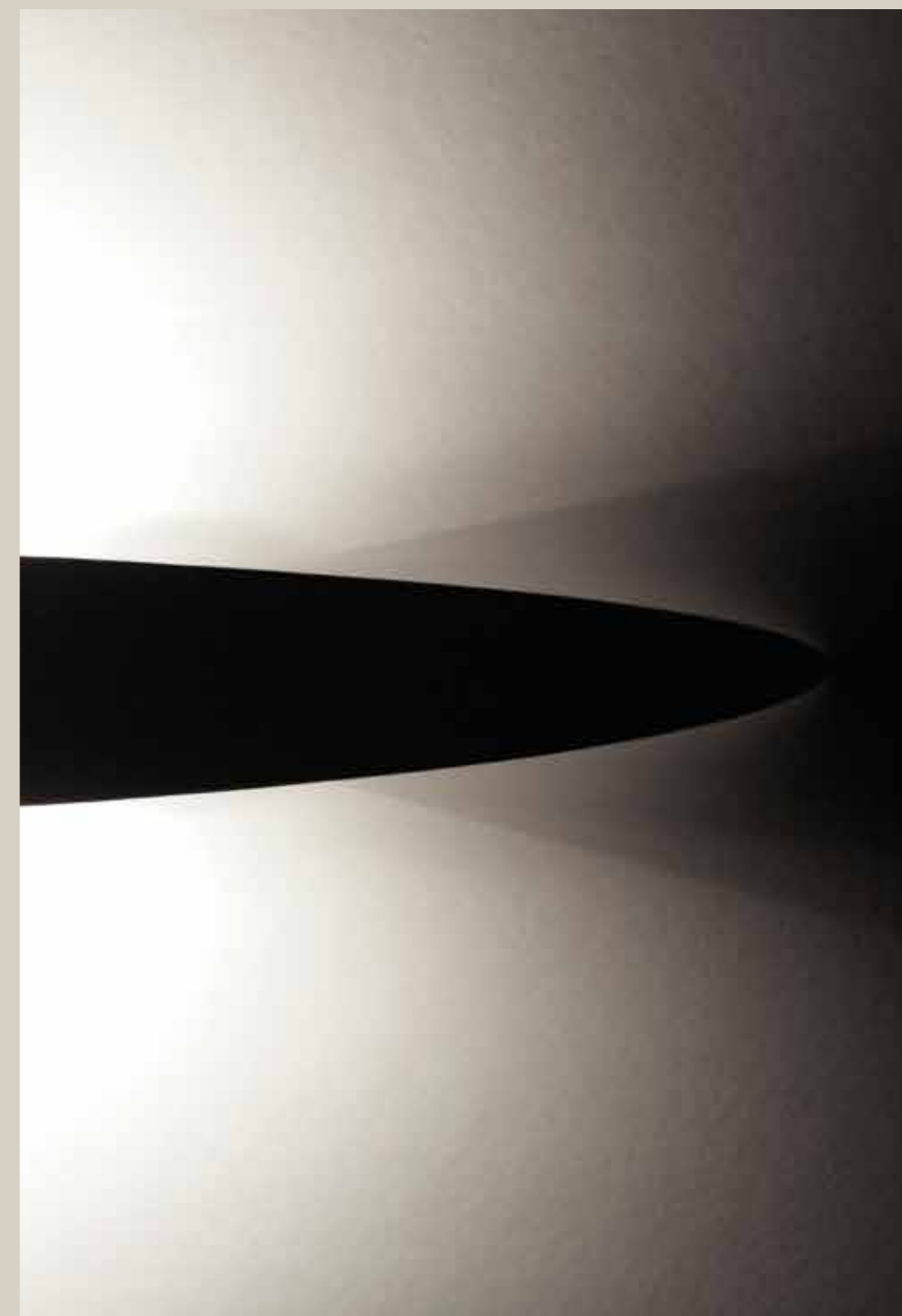

Ci
design S. Cornelissen
2015

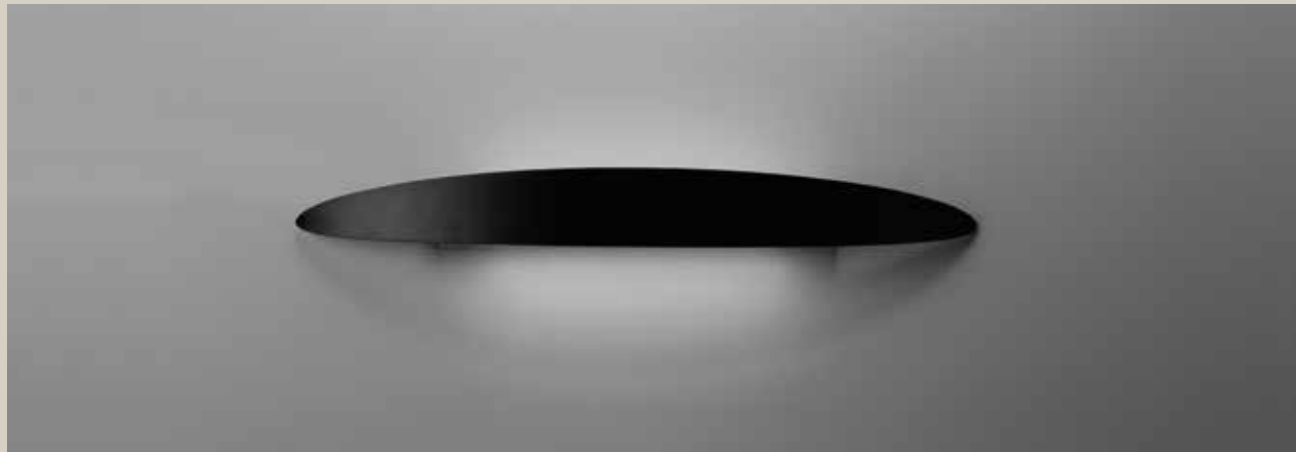

.02 Nero - Black

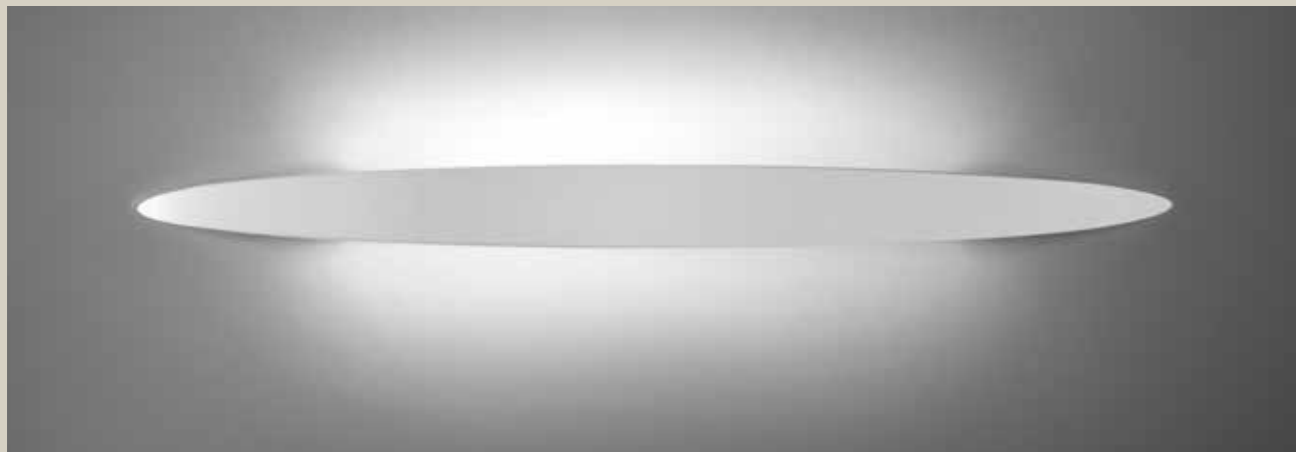

.01 Bianco - White



4574 1,7 kg
 .01 Bianco - White
 .02 Nero - Black

/W LED 12,5W 1930lm 4000K
/WW LED 12,5W 1840lm 3000K

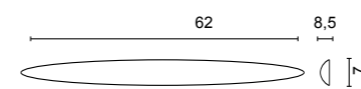

4576 3 kg
 .01 Bianco - White
 .02 Nero - Black

/W LED 37,5W 5790lm 4000K
/WW LED 37,5W 5520lm 3000K

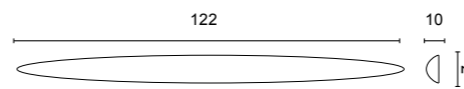

4575 2 kg
 .01 Bianco - White
 .02 Nero - Black

/W LED 25W 3860lm 4000K
/WW LED 25W 3680lm 3000K

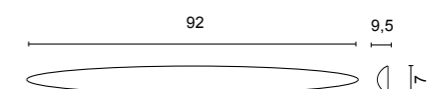

4577 3,9 kg
 .01 Bianco - White
 .02 Nero - Black

/W LED 50W 7720lm 4000K
/WW LED 50W 7360lm 3000K

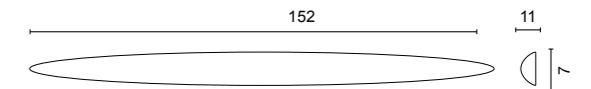



Lampade a sospensione o soffitto di grandi dimensioni dotate di sorgente LED. Struttura ed elementi modulari del diffusore sono realizzati in alluminio verniciato. Le versioni a soffitto sono dotate di un disco bianco per nascondere l'alimentatore e simulare l'effetto di un apparecchio a scomparsa. Alimentatore incluso.

Large Suspensions or ceiling lamps fitted with LED light engine. Structure and modular elements of the shade realized in painted aluminum. Ceiling version includes a white panel to hide converter and simulate the effect of a recessed fixture. Converter on board.

Suspensions ou lampes à plafond de grandes dimensions équipés avec des sources LED. Structure et éléments modulaires du diffuseur réalisés en aluminium verni. Les versions à plafond incluent un panneau blanc pour cacher le convertisseur et simuler l'effet d'un luminaire encastré. Convertisseur inclus.

Großformatige Pendel- oder Deckenleuchten mit LED Technik. Struktur und modulare Elemente des Schirms aus lackiertem Aluminium. Die Deckenleuchten werden mit einem weißen, lackierbaren Paneel zur Abdeckung des Konverters geliefert (gleicher Effekt wie bei Einbau). Inklusive Konverter.





Lámparas colgantes o de techo de grande diámetro equipadas con fuente de luz LED. Estructura y elementos modulares de la sombra realizados en aluminio pintado. Versión de techo incluye un panel blanco para ocultar el convertidor y simular el efecto de un aparato empotrado. Convertidor incluido.

Большой подвесной или потолочный светильник на светодиодах. Структура и детали из окрашенного алюминия. Потолочные модели с окрашиваемой панелью, за которой прячется конвертер. Конвертер включен.







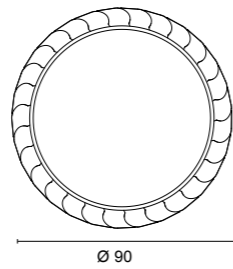
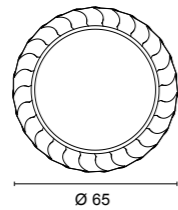
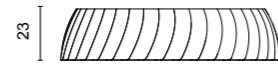
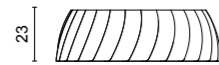

Megavide
design S. Cornelissen
2015



5536	3 kg	5537	4 kg
.01 Bianco - White		.01 Bianco - White	
/W LED 22,5W 3000lm 4000K CRI>90		/W LED 33W 4400lm 4000K CRI>90	
/WW LED 22,5W 2975lm 3000K CRI>90		/WW LED 33W 4363lm 3000K CRI>90	
/XW LED 22,5W 2687lm 2700K CRI>90		/XW LED 33W 3942lm 2700K CRI>90	
 		 	



1530	2,5 kg	1531	3,5 kg	1532	4,5 kg
.01 Bianco - White		.01 Bianco - White		.01 Bianco - White	
/W LED 22,5W 3000lm 4000K CRI>90		/W LED 33W 4400lm 4000K CRI>90		/W LED 45W 6000lm 4000K CRI>90	
/WW LED 22,5W 2975lm 3000K CRI>90		/WW LED 33W 4363lm 3000K CRI>90		/WW LED 45W 5950lm 3000K CRI>90	
/XW LED 22,5W 2687lm 2700K CRI>90		/XW LED 33W 3942lm 2700K CRI>90		/XW LED 45W 5375lm 2700K CRI>90	
 		 		 	

/DIM Dimmerabile - Dimmable

/DIM Dimmerabile - Dimmable

/DIM Dimmerabile - Dimmable

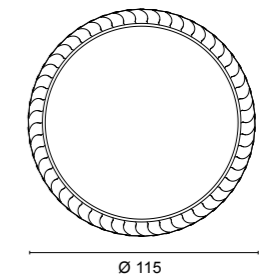
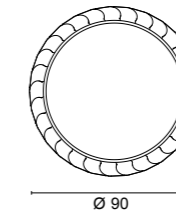
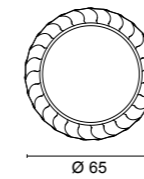
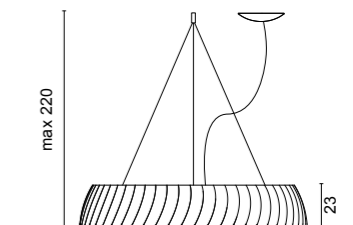
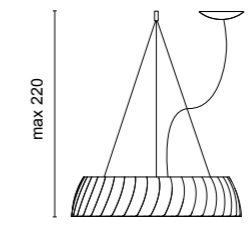
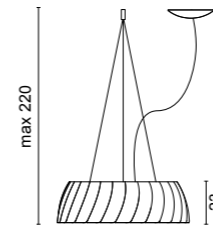

Megavide
design S. Cornelissen



Megavide
design S. Cornelissen





Lampada da parete con o senza luce orientabile da lettura integrata. Disponibili nuove versioni complete di piano d'appoggio. Diffusore in metacrilato opalino o rivestito in tessuto tecnico ignifugo nero o grigio perla. La luce diffusa viene fornita da una piastra LED a tensione di rete 220/240V, mentre per la luce da lettura viene utilizzando un power LED con driver incluso.

Wall lamps with or without integrated adjustable reading light.
Now available also in new version with tabletop. Diffuser in opal white methacrylate or coated with composite fireproof net in black or pearl grey color.
Ambiance lighting is granted by a LED plate for main supply voltage 220-240V, whereas personal reading light is supplied by a power LED with converter on board.

Appliques avec ou sans lampe de lecture réglable intégrée.
Maintenant disponible aussi dans la nouvelle version avec tablette.
Diffuseur en méthacrylate blanc opalin ou recouvert d'un filet composite ignifugé noir ou gris perle.
L'éclairage d'ambiance est assuré par une plaque LED à tension du réseau 220-240V, La lumière de lecture est fournie par une LED de puissance avec convertisseur intégré.

Wandleuchten mit oder ohne integriertem ausrichtbarer Leselicht.
Jetzt auch in neuer Version mit Tischplatte verfügbar.
Diffusor aus opalweißem Methacrylat oder beschichtet mit feuerfestem Netz in schwarz oder perlgrau.
Die Wandleuchte ist mit eine LED-Platte für Netzspannung 220-240V ausgestattet, während das persönliche Leselicht ist mit Power-LED und integriertem Konverter bestückt.

Lámparas de pared con o sin luz de lectura ajustable integrada.
Ahora disponible también en una nueva versión con mesita.
Difusor en metacrilato blanco opal o recubierto con red de material compuesto ignífugo en color negro o gris perla.
Por la iluminación ambiente se utiliza una placa de LED para tensión de red 220-240V, mientras la luz de lectura es suministrada para un LED de potencia con convertidor integrado.

Настенный светильник с направляемой лампой для чтения или без нее. Есть новые варианты с настольной подставкой.
Диффузор из матового метакрилата или из огнестойкой технической ткани черного или серого перламутрового цвета.
Рассеянный свет дает светодиодная плата сетевого напряжения 220в, а для чтения используется светодиод со встроенным драйвером.



Pupilla
design M. Mussapi
2015

Pupilla
design M. Mussapi



.01 Bianco - White



.37 Tessuto grigio perla - Pearl grey cloth

Pupilla
design M. Mussapi



.36 Tessuto nero - Black cloth

4571 1,3 kg
.01 Metacrilato bianco satinato - Opal white methacrylate
.36 Tessuto nero - Black cloth
.37 Tessuto grigio perla - Pearl grey cloth

/WW LED 10W 1200lm 3000K + LED 1W 130lm 3000K

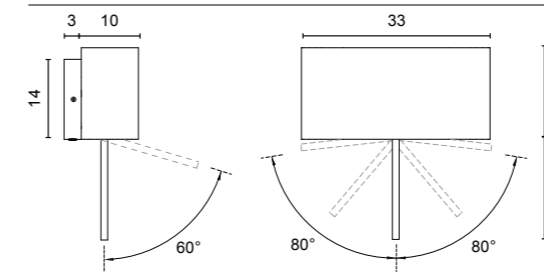

4572 0,9 kg
.01 Metacrilato bianco satinato - Opal white methacrylate
.36 Tessuto nero - Black cloth
.37 Tessuto grigio perla - Pearl grey cloth

/WW LED 10W 1200lm 3000K

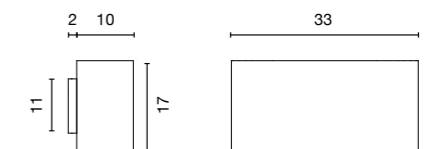

Pupilla
design M. Mussapi



Pupilla
design M. Mussapi



4573 3 kg

.01 Metacrilato bianco satinato - Opal white methacrylate

.36 Tessuto nero - Black cloth

.37 Tessuto grigio perla - Pearl grey cloth

/WW LED 10W 1200lm 3000K + LED 1W 130lm 3000K

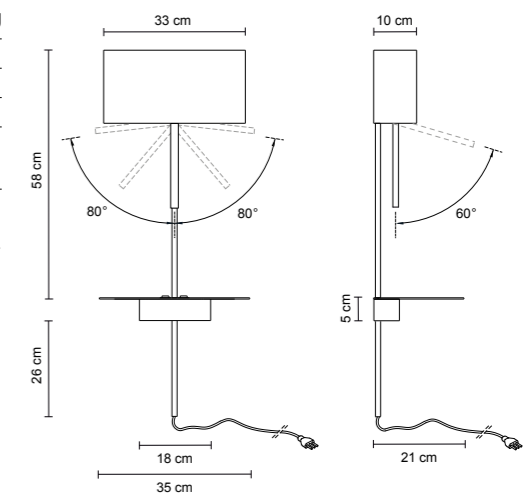

Pupilla
design M. Mussapi



Pupilla
design M. Mussapi

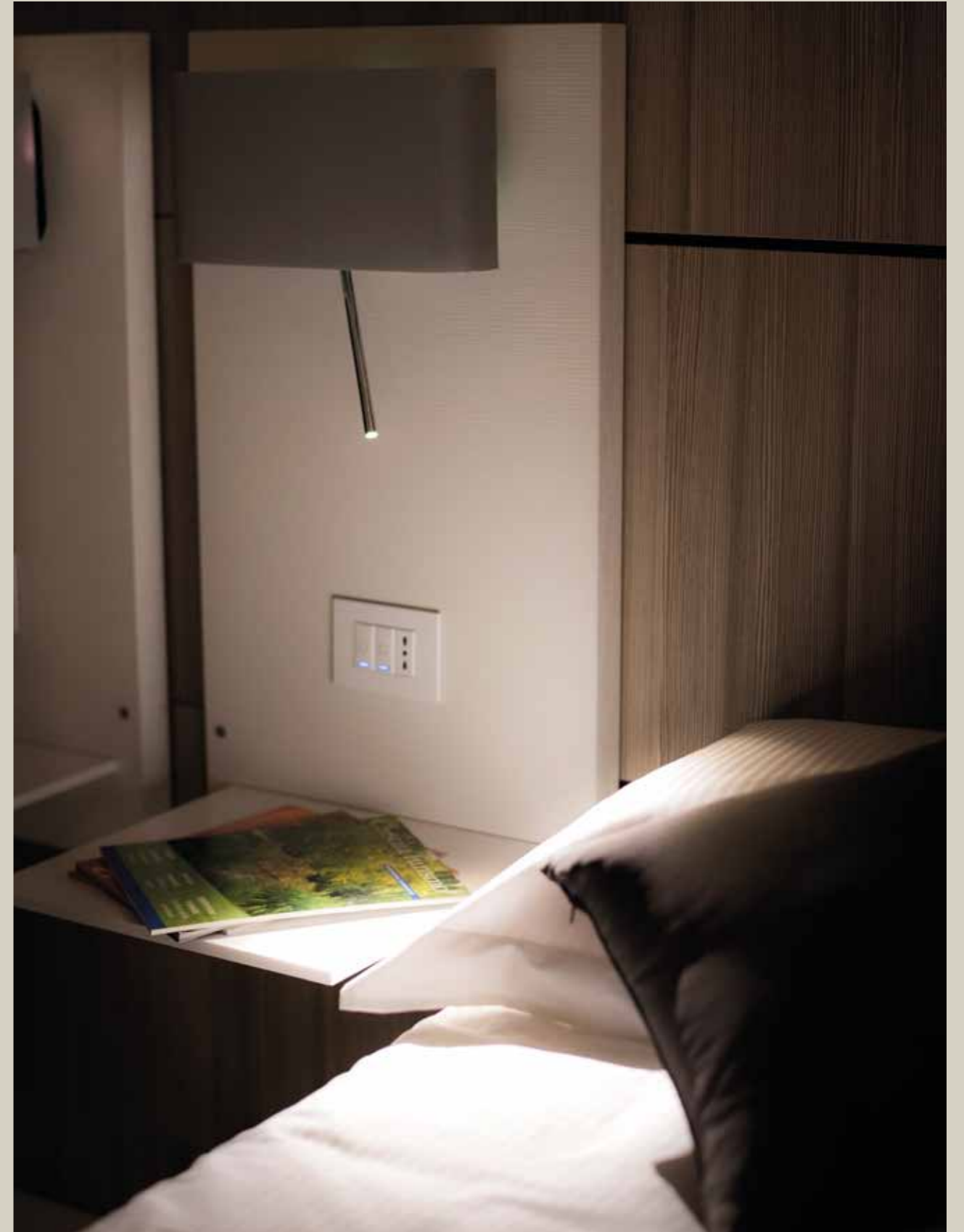

Sistema di apparecchi da parete realizzati con sorgenti COB LED. Corpo in metallo verniciato, disponibile in due dimensioni, finiture: bianco, nero e sabbia. Include accessorio per cablaggio passante che permette di collegare più apparecchi ad un unico punto d'alimentazione. Alimentatore integrato.

System of wall lamps fitted with COB LED light engine.

Painted metal body available in two dimensions, finishes: white, black and sand. A wiring accessory allowing to connect more units to a single cable outlet is included. Converter on board.

Système d'appliques équipées avec technologie COB LED .

Corps en métal verni disponible en deux dimensions, finitions: blanc, noir et sable. Un accessoire de câblage inclus permet de connecter plusieurs unités à un seul point d'alimentation. Convertisseur intégré.

Wandleuchten-System mit COB LED-Modulen. Körper aus lackiertem Metall, erhältlich in zwei Größen. Ausführungen: weiß, schwarz und sand. Zubehör zur Durchgangsverdrahtung mehrerer Elemente inbegriffen. Integrierter Konverter.

Sistema de lámparas de pared equipados con fuente de luz COB LED.

Cuerpo de metal pintado disponible en dos tamaños, acabados: blanco, negro y arenoso. Está incluido un accesorio que permite conectar mas unidades a un solo punto de alimentación.

Convertidor integrado.

Система настенных светильников со светодиодами на плате. Металлический корпус есть в 2 размерах и цветах:

белый, черный песчаный. Аксессуар, позволяющий подключить несколько приборов к одному силовому кабелю. Конвертер включен.



Mats
design S. Cornelissen
2015

Mats

design S. Cornelissen



.01 Bianco - White



.02 Nero - Black



.35 Sabbia - Sand

Mats

design S. Cornelissen



4564

0,6 kg

.01	Bianco - White
.02	Nero - Black
.35	Sabbia - Sand

/W	LED 6,5W 865lm 4000K
/WW	LED 6,5W 844lm 3000K
/XW	LED 6,5W 825lm 2700K



16x16 7

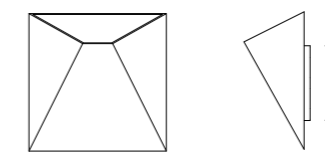

0,8

4565

1 kg

.01	Bianco - White
.02	Nero - Black
.35	Sabbia - Sand

/W	LED 9,8W 1210lm 4000K
/WW	LED 9,8W 1111lm 3000K
/XW	LED 9,8W 1085lm 2700K



21x21 9,2

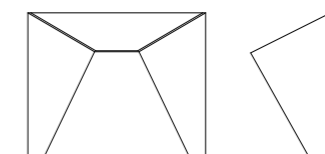

0,8

Mats

design S. Cornelissen

Esempio di installazione multipla da un unico punto luce
Example of multiple installation starting from a single cable outlet

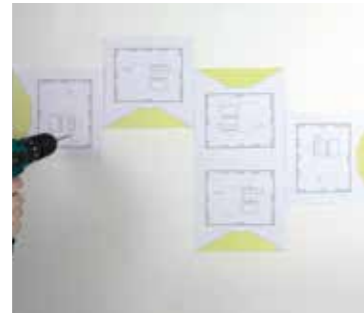

Posizionamento dime e foratura in base alla posizione desiderata

Positioning of the drilling template

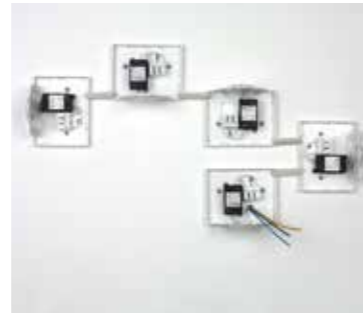

Fissaggio montature con uscita alimentazione da un solo punto luce e predisposizione collegamenti

Installation of mounting plates starting from a single cable outlet

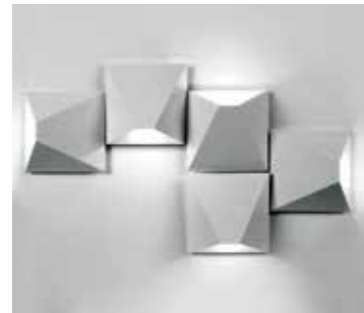

Montaggio maschere e accensione

Assembly of the front plates

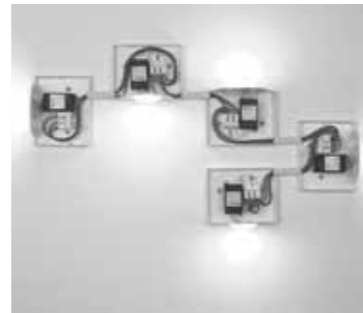

Realizzazione cablaggio passante tra le singole montature

Realization of electrical connection between single units



Mats

design S. Cornelissen

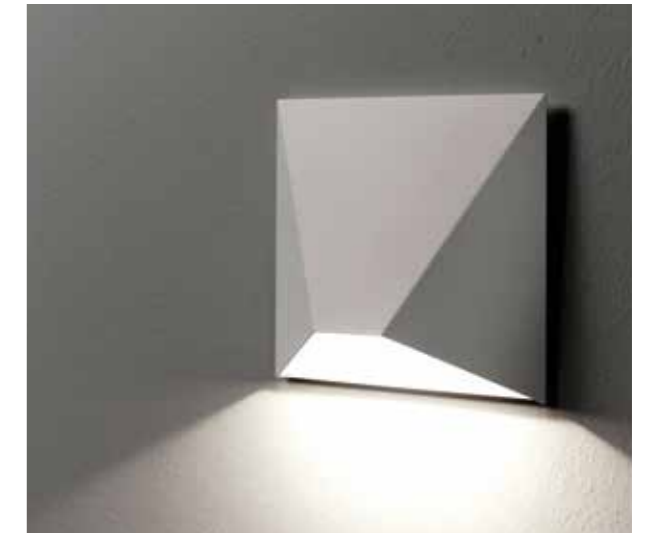

Lampada a sospensione per luce d'accento.
Corpo in metallo in finiture verniciate o galvaniche.
Apertura del fascio 40°.
La lampada è fornita con particolare per decentramento.

Suspension lamp for accent lighting.
Metal body in painted or galvanized finishes.
40 ° beam opening.
The lamp is supplied with an accessory for displacement.

Lampe à suspension pour éclairage d'accent.
Corps en métal disponible dans des finitions vernies ou galvaniques.
Ouverture du faisceau à 40 °.
La lampe est fournie avec un accessoire pour le déplacement.

Hängeleuchte für Akzentbeleuchtung.
Metallkörper in lackierter oder galvanischer Ausführung.
Ausstrahlung 40 °.
Die Lampe ist mit Zubehör für Verschiebung geliefert.

Colgante para iluminación de acento.
Cuerpo de metal en acabados pintados o galvanicos.
Apertura de haz de 40 °.
La lámpara se suministra con accesorio para desplazamiento.

Подвесной светильник для акцентирующего света. Корпус из окрашенного или гальванически обработанного металла. Угол света 40 градусов. Снабжен системой для децентрализации.



Pool
design ABS Studio
2011



1504 0,9 kg

- .01** Bianco - White
- .02** Nero - Black
- .31** Cromato lucido - Shiny chromed
- .38** Ramato lucido - Shiny copper

LED 2W 220lm 3000K

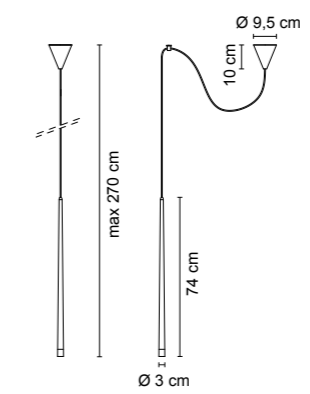



Lampada LED da soffitto o sospensione.
Corpo in trafilata di alluminio con diffusore in metacrilato satinato. Il driver è integrato nella struttura della lampada.
RAIL QUADRA è pensata come un'unica grande cornice, un percorso chiuso di luce che definisce e sottolinea lo spazio sottostante.
A richiesta sono fornibili versioni con altre dimensioni e finiture.

Ceiling or suspension LED lamp. Lamp structure of extruded aluminum with opal methacrylate diffuser. Driver is located inside the lamp frame. RAIL QUADRA is conceived as a single lighted frame; a closed circuit of light that defines and highlight the underneath space. Fixtures with different dimensions and finishes are available upon request.

Plafonnier ou lampe à suspension LED.
Structure de la lampe en aluminium extrudé avec diffuseur en méthacrylate opale.
Le driver est situé à l'intérieur de la structure de la lampe.
RAIL QUADRA est conçue comme un seul cadre éclairé; un circuit fermé de lumière qui définit et met en évidence l'espace sous-jacent.
Versions avec différentes dimensions et finitions sont disponibles sur demande.

Decken- oder Hängeleuchte.
Struktur aus stranggepresstem Aluminium mit Diffusor aus opalem Methacrylat.
Der Driver ist integriert.
RAIL QUADRA ist als einzelner beleuchteter Rahmen konzipiert;
ein geschlossener Lichtkreis, der den darunter liegenden Raum definiert und hervorhebt.
Leuchten mit verschiedenen Abmessungen und Ausführungen sind auf Anfrage erhältlich.

Lámpara LED de techo o suspensión.
Estructura de aluminio extruido con difusor de metacrilato opal. El driver es colocado dentro del cuerpo de la lámpara.
RAIL QUADRA se concibe como un único marco iluminado; un circuito cerrado de luz que define y resalta el espacio debajo.
Versiones con diferentes dimensiones y acabados están disponibles bajo pedido.

Потолочный или подвесной светодиодный светильник. Корпус из экструзионного алюминия, диффузор из матового метакрилата. Драйверы интегрированы в корпус.
Rail Quadra задуман как единая большая светящаяся рамка, освещающая и формирующая пространство под собой.
По запросу могут изготавливаться варианты с другими размерами и отделкой.



Rail Quadra
design ABS Studio
2018



5562

3,5 kg

- .01** Bianco - White
- .02** Nero - Black

/W LED 54W 7350lm 4000K CRI>90

/WW LED 54W 7140lm 3000K CRI>90

/XW LED 54W 6600lm 2700K CRI>90

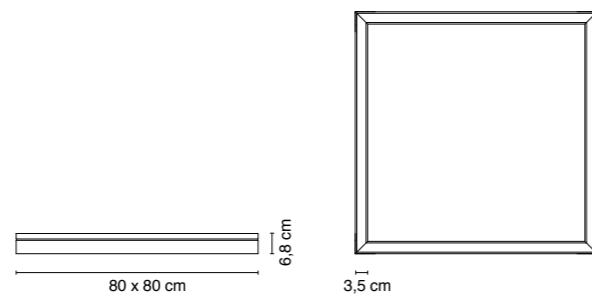

1561

3,8 kg

- .01** Bianco - White
- .02** Nero - Black

/W LED 54W 7350lm 4000K CRI>90

/WW LED 54W 7140lm 3000K CRI>90

/XW LED 54W 6600lm 2700K CRI>90

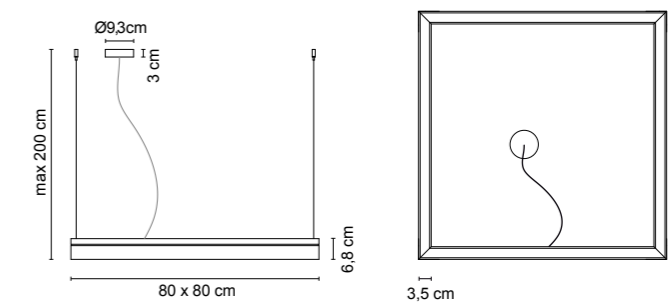

Serie di lampade orientabili da parete, sospensione, tavolo e terra. I circuiti lineari LED con CRI 90, garantiscono una resa cromatica ottimale per l'illuminazione di quadri. Struttura in alluminio verniciato bianco, diffusore in metacrilato satinato. La versione da terra prevede anche un utilizzo a parete grazie all'apposito attacco incluso. Le versioni a sospensione sono realizzabili, a richiesta, in misure speciali modulari.

Series of adjustable wall-lamps, suspensions, table or standing.
Fitted with linear LED circuits granting CRI 90 in order to achieve optimal color rendering for pictures lighting. Structure in white painted aluminum and satin methacrylate diffuser.
The floor version includes an additional bracket that allows wall installation.
Suspended versions are available, upon request, in modular special lengths.

Série de lampes réglables applique, suspension, table ou lampadaire. Équipé avec circuits linéaires LED délivrant un CRI 90 pour garantir une rendue couleurs optimale dans l'éclairage de tableau. Structure en aluminium laqué blanc et diffuseur en méthacrylate satiné. La version lampadaire est doué d'une patère supplémentaire qui permet l'installation murale. Les versions suspension sont disponibles, sur requête, dans des longueurs modulaires spéciaux.

Serie von ausrichtbarer Wand-, Pendel-, Tisch- und Stehleuchten.
Ausgestattet mit LED-Modulen CRI >90, um die optimale Farbwiedergabe bei der Beleuchtung von Bildern zu erzielen. Struktur aus weiß lackiertem Aluminium und Diffusor aus satiniertem Acrylglas.
Die Stehleuchte bietet eine zusätzliche Halterung für eine etwaige Wandbefestigung. Pendelversionen sind, auf Anfrage, auch in modularen Sonderlängen lieferbar.

Serie de lámparas ajustables de pared, colgantes, mesa y de pie.
Equipados con circuitos lineares LED con CRI 90 para alcanzar un índice de reproducción cromática óptimo para la iluminación de cuadros. Estructura de aluminio pintado blanco y difusor de metacrilato satinado.
La versión de pie incluye un soporte adicional que permite la instalación a pared.
Las versiones suspendidas están disponibles, previa solicitud, en medidas modulares especiales.

Серия настенных, подвесных или напольных поворотных светильников. Линейные светодиодные модули гарантируют индекс цветопередачи CRI>90, идеальны для подсветки картин. Корпус из окрашенного алюминия, диффузор матовый метакрилат. Торшер снабжен кронштейном, позволяющим крепить также к стене. Подвесные варианты могут быть исполнены по запросу в других размерах.



Lancia
design P. Peperè
2015



Il profilo di luce può essere orientato a 360°.
The light profile can be oriented 360°.

1540	1,5 kg
.01	Bianco - White
.02	Nero - Black
/W	LED 27W 3600lm 4000K CRI>90
/WW	LED 27W 3570lm 3000K CRI>90
/XW	LED 27W 3228lm 2700K CRI>90

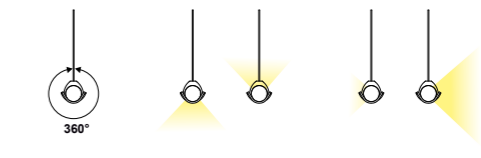
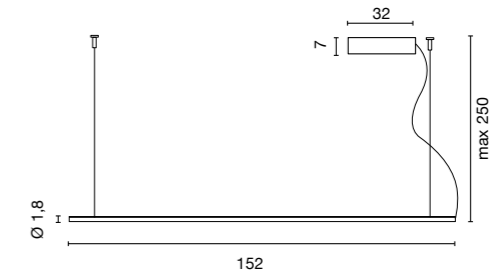

CUSTOM SIZE - Tabella lunghezze disponibili a richiesta. Table of available lengths on request.

cm.	watt	2700K /XW	lm	3000K /WW	lm	4000K /W	lm
102	18W	A1540 * /100/XW	2150	A1540 * /100/WW	2380	A1540 * /100/W	2400
127	22,5W	A1540 * /125/XW	2687	A1540 * /125/WW	2975	A1540 * /125/W	3000
** 152	27W	1540 * /XW	3228	1540 * /WW	3570	1540 * /W	3600
177	31,5W	A1540 * /175/XW	3766	A1540 * /175/WW	4165	A1540 * /175/W	4200
202	36W	A1540 * /200/XW	4304	A1540 * /200/WW	4760	A1540 * /200/W	4800
227	40,5W	A1540 * /225/XW	4842	A1540 * /225/WW	5355	A1540 * /225/W	5400
252	45W	A1540 * /250/XW	5380	A1540 * /250/WW	5950	A1540 * /250/W	6000
277	49,5W	A1540 * /275/XW	5918	A1540 * /275/WW	6545	A1540 * /275/W	6600
302	54W	A1540 * /300/XW	6456	A1540 * /300/WW	7140	A1540 * /300/W	7200

* Finiture - Finishes:

.01 Bianco - White

.02 Nero - Black

** Articolo standard a catalogo.

Standard catalogue item.

A richiesta sono disponibili versioni dimmerabili PUSH, 1...10V o DALI.
PUSH, 1...10V or DALI dimmable options available upon request.

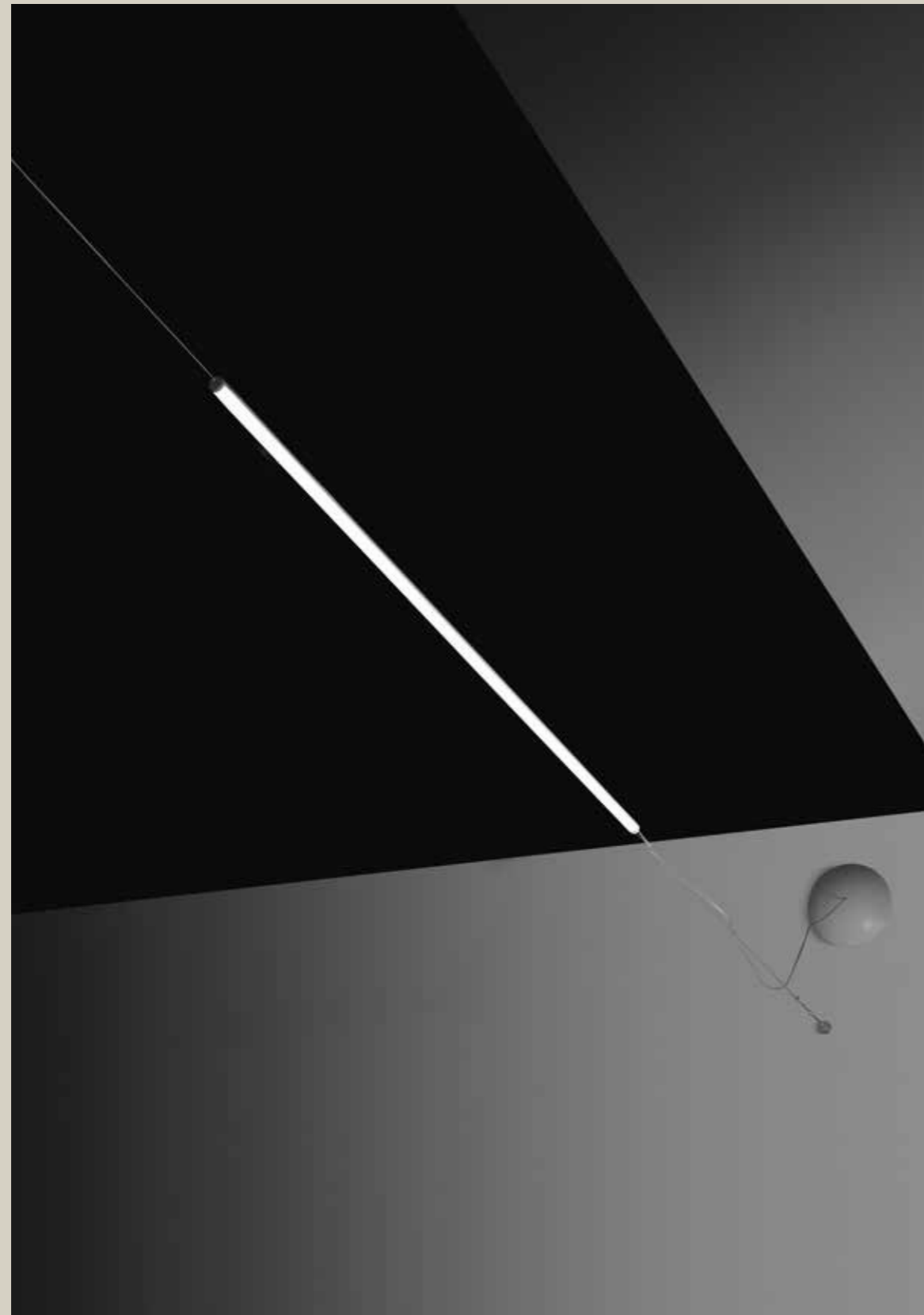

1565.01/200/... + 0965.31

1565

- .01** Bianco - White
- .02** Nero - Black

L.100cm 0,80 kg

/100/W LED 18W 2400lm 4000K CRI>90

/100/WW LED 18W 2380lm 3000K CRI>90

/100/XW LED 18W 2150lm 2700K CRI>90

L.150cm 1,0 kg

/150/W LED 27W 3600lm 4000K CRI>90

/150/WW LED 27W 3570lm 3000K CRI>90

/150/XW LED 27W 3228lm 2700K CRI>90

L.200cm 1,20 kg

/200/W LED 36W 4800lm 4000K CRI>90

/200/WW LED 36W 4760lm 3000K CRI>90

/200/XW LED 36W 4304lm 2700K CRI>90

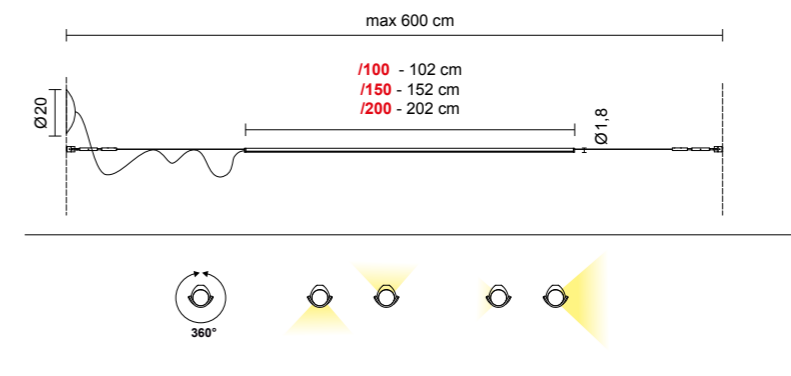

Accessori - Accessories

0965.31

Coppia di tenditori cromati con cavo in acciaio 6mt.

2 chromed brass tensors with steel cable 6mt.



da ordinare separatamente
to be ordered separately





4567 0,80 kg

.01 Bianco - White
.31 Cromato - Chromed
.31.31 Completamente cromato
Totally chromed

/W LED 9W 1200lm 4000K CRI>90
/WW LED 9W 1190lm 3000K CRI>90
/XW LED 9W 1075lm 2700K CRI>90

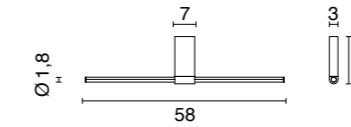

4568 1,00 kg

.01 Bianco - White
.31 Cromato - Chromed
.31.31 Completamente cromato
Totally chromed

/W LED 18W 2400lm 4000K CRI>90
/WW LED 18W 2380lm 3000K CRI>90
/XW LED 18W 2150lm 2700K CRI>90

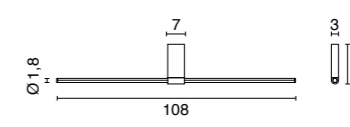
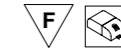

4569 0,90 kg

.01 Bianco - White
.31 Cromato - Chromed
.31.31 Completamente cromato
Totally chromed

/W LED 16,5W 1987lm 4000K CRI>90
/WW LED 16,5W 2189lm 3000K CRI>90
/XW LED 16,5W 2208lm 2700K CRI>90

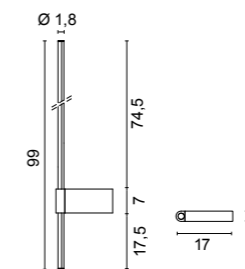

Art. 4567 - Art. 4568 - Art. 4569

Diffusore orientabile.
Diffuser orientable.

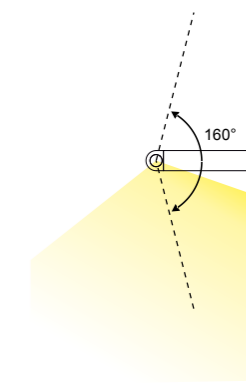



Lancia
design P. Pepere



Lancia
design P. Pepere



Solo lampada da soffitto, diffusore non orientabile.
Only ceiling lamp, diffuser not orientable.

4570 0,90 kg

.01 Bianco - White

/W LED 22,5W 3000lm 4000K CRI>90

/WW LED 22,5W 2975lm 3000K CRI>90

/XW LED 22,5W 2688lm 2700K CRI>90

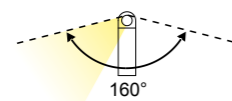
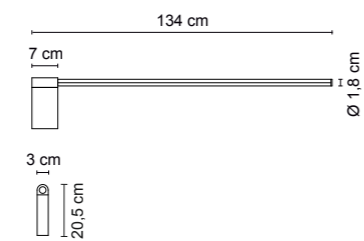
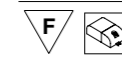

5567 0,80 kg

.01 Bianco - White

.31 Cromato - Chromed

.31.31 Completamente cromato
Totally chromed

/W LED 9W 1200lm 4000K CRI>90

/WW LED 9W 1190lm 3000K CRI>90

/XW LED 9W 1075lm 2700K CRI>90

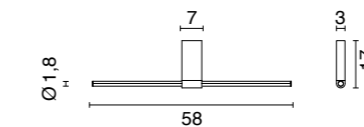

5568 1,00 kg

.01 Bianco - White

.31 Cromato - Chromed

.31.31 Completamente cromato
Totally chromed

/W LED 18W 2400lm 4000K CRI>90

/WW LED 18W 2380lm 3000K CRI>90

/XW LED 18W 2150lm 2700K CRI>90

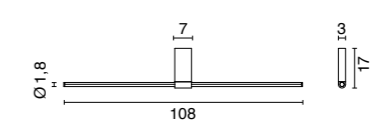

Lancia
design P. Pepere



La lampada è fornita con dimmer touch integrato nel profilo.
The lamp is supplied with a touch dimmer integrated in the profile.

2506 2,20 kg
.01 Bianco - White
.02 Nero - Black

AW LED 9W 1200lm 4000K CRI>90
AWW LED 9W 1190lm 3000K CRI>90
AXW LED 9W 1075lm 2700K CRI>90

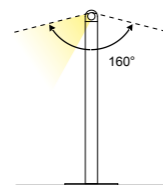
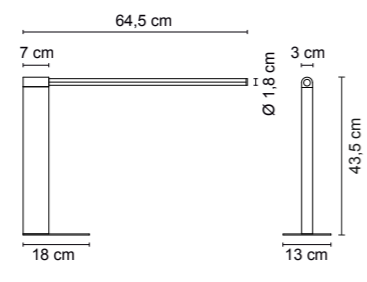

Lancia
design P. Pepere



3506 2,5 kg
.01 Bianco - White

AW LED 16,5W 2200lm 4000K CRI>90
AWW LED 16,5W 2182lm 3000K CRI>90
AXW LED 16,5W 1971lm 2700K CRI>90

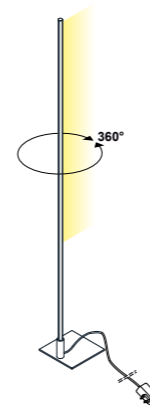
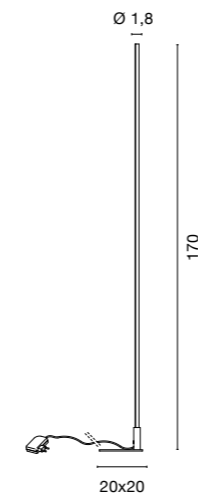



Apparecchi lineari LED a sospensione, parete e soffitto. Terminali in ABS. Bianco o cromato entrambi in dotazione nelle versioni a parete e soffitto. Le sospensioni sono provviste di rosone con converter ed a richiesta sono realizzabili in soluzioni dimmerabili.

Linear LED fixture available as suspension or ceiling/wall surface mounted. End pieces in white or chromed ABS, both options are included in the wall/ceiling version. Suspensions are provided with a canopy that contains the driver. Dimmable options available upon request.

Luminaire linéaire à LED disponible en suspension ou pour montage au plafond/mur. Terminales en ABS blanc ou chromé, les deux options sont incluses dans les versions applique/plafond. Les suspensions incluent une rosace contenant le driver et sur demande sont disponibles dans des options dimmables.

Lineare LED-Leuchte als Pendelleuchte oder für Decken- / Wandmontage erhältlich. Endstücke aus weißem oder verchromtem ABS, beide Optionen sind inbegriffen in Decken- / Wandmontage. Die Pendelleuchten sind komplett mit Baldachin und Driver geliefert. Dimmbarer Versionen erhältlich auf Anfrage.

Luminaria LED lineal disponible como colgante o para montaje a techo/pared. Terminales en ABS blanco y cromado, ambas opciones están incluidas en las versiones techo/pared. Las versiones colgante incluyen un florón que contiene el driver. Opciones regulables están disponibles en las bajo pedido.

Линейные светодиодные модули, подвесные, настенные и потолочные, в комплекте с концевыми заглушками из хромированного термопластика. Подвесы в комплекте с потолочной розеткой и конвертером и по запросу могут иметь диммеры PUSH, 1...10V, DALI. Светильники могут быть в разных размерах (см. таблицу).

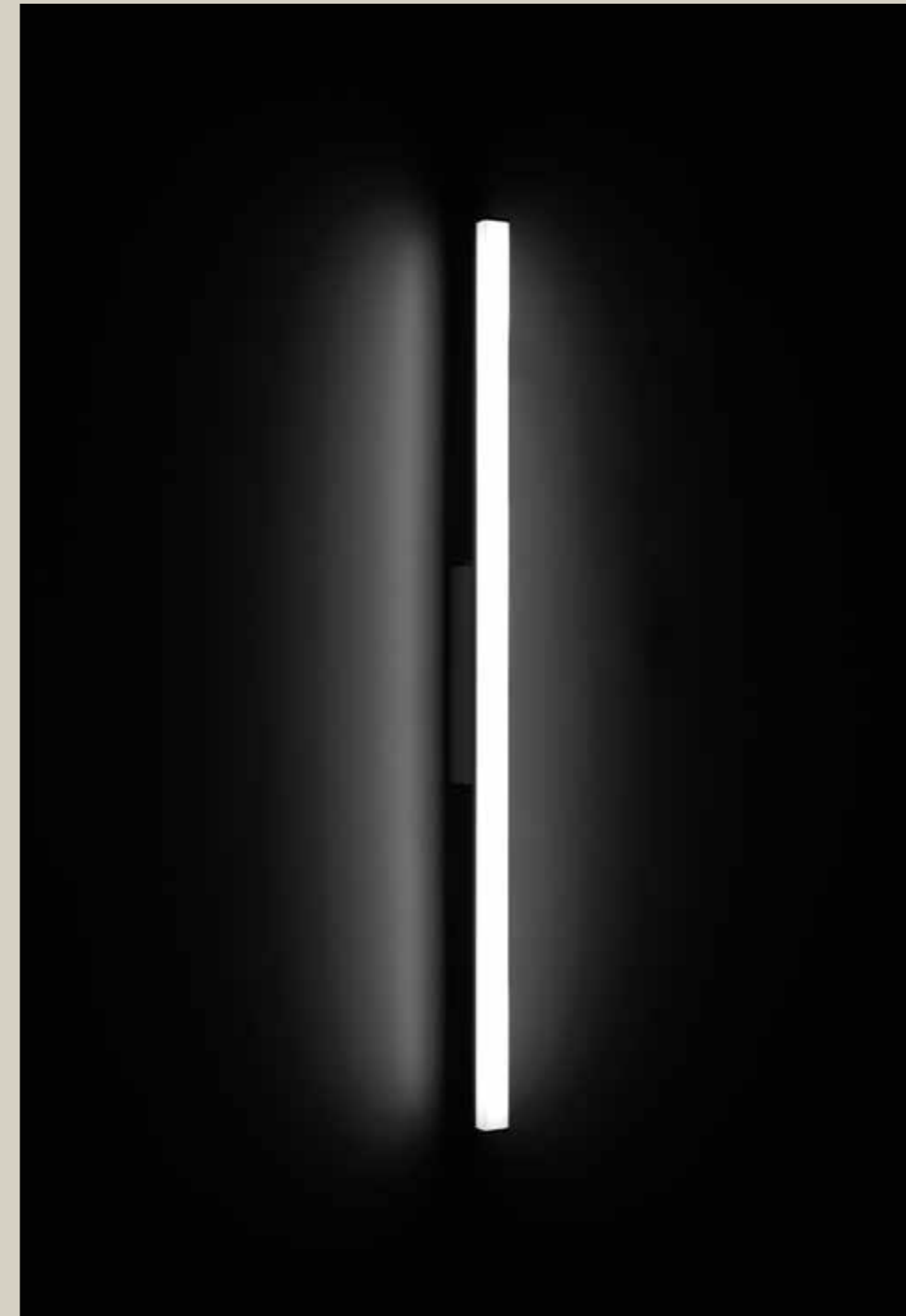

Extra
design U.T. EgoLuce
2017



1560 1,5 kg
.01 Bianco - White

/W LED 15W 2000lm 4000K CRI>90

/WW LED 15W 1900lm 3000K CRI>90

/XW LED 15W 1780lm 2700K CRI>90

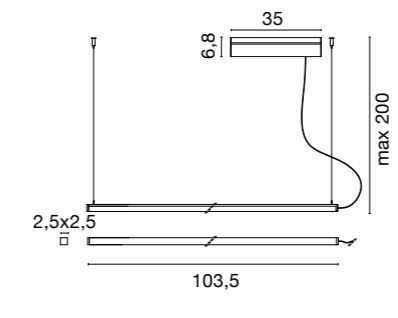

CUSTOM SIZE - Tabella lunghezze disponibili a richiesta. Table of available lengths on request.

	cm.	watt	2700K (XW)	lm	3000K (WW)	lm	4000K (W)	lm
**	103,5	15W	1560.01/XW	1780	1560.01/WW	1900	1560.01/W	2000
	123,5	18W	A1560.01/120/XW	2136	A1560.01/120/WW	2280	A1560.01/120/W	2400
	143,5	21W	A1560.01/140/XW	2492	A1560.01/140/WW	2660	A1560.01/140/W	2800
	163,5	24W	A1560.01/160/XW	2848	A1560.01/160/WW	3040	A1560.01/160/W	3200
	183,5	27W	A1560.01/180/XW	3204	A1560.01/180/WW	3420	A1560.01/180/W	3600
	203,5	30W	A1560.01/200/XW	3560	A1560.01/200/WW	3800	A1560.01/200/W	4000
	223,5	33W	A1560.01/220/XW	3916	A1560.01/220/WW	4180	A1560.01/220/W	4400
	243,5	36W	A1560.01/240/XW	4272	A1560.01/240/WW	4560	A1560.01/240/W	4800
	263,5	39W	A1560.01/260/XW	4628	A1560.01/260/WW	4940	A1560.01/260/W	5200
	283,5	42W	A1560.01/280/XW	4984	A1560.01/280/WW	5320	A1560.01/280/W	5600
	303,5	45W	A1560.01/300/XW	5340	A1560.01/300/WW	5700	A1560.01/300/W	6000

** Articolo standard a catalogo - Standard catalogue item

Extra
design U.T. EgoLuce



Terminali in ABS bianco o cromato entrambi in dotazione.
End pieces in white or chromed ABS, both options are included in the product.

Extra
design U.T. EgoLuce

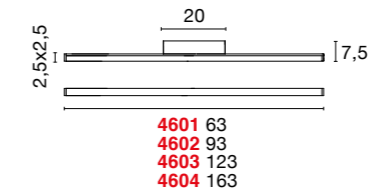

4601 0,80 kg

.31 Cromato - Chromed

/W LED 9W 1200lm 4000K CRI>90

/WW LED 9W 1140lm 3000K CRI>90

/XW LED 9W 1060lm 2700K CRI>90



4602 0,9 kg

.31 Cromato - Chromed

/W LED 13,5W 1800lm 4000K CRI>90

/WW LED 13,5W 1710lm 3000K CRI>90

/XW LED 13,5W 1602lm 2700K CRI>90



4603 1 kg

.31 Cromato - Chromed

/W LED 18W 2400lm 4000K CRI>90

/WW LED 18W 2280lm 3000K CRI>90

/XW LED 18W 2136lm 2700K CRI>90



4604 1,2 kg

.31 Cromato - Chromed

/W LED 24W 3200lm 4000K CRI>90

/WW LED 24W 3040lm 3000K CRI>90

/XW LED 24W 2848lm 2700K CRI>90



Sospensione con portalamпада GU10 disponibile in versione totalmente bianca o bianca con finitura interna in cromato, oro satinato o rame.

Suspension with GU10 lampholder available in total white finish or white with internal diffuser in chrome, satin gold or copper.

Suspension avec douille GU10 disponible en finition blanc total ou blanc avec diffuseur interne en chrome, or satiné ou cuivre.

Pendelleuchte mit GU10 Lampenfassung. Ausführungen: total weiß oder weiß mit Innendiffuser in Chrom, satiniertem Gold oder Kupfer.

Supensión con portalámparas GU10 disponible en acabado blanco total o blanco con difusor interno en cromo, oro satinado o cobre.

Подвесной светильник с цоколем GU10 полностью белый или белый с внутренней отделкой из хрома, брашированного золота или меди.



Rulò
design ABS Studio
2011



.01 Bianco
White



.01.25 Dorato satinato
Satin gold



.01.31 Cromato
Chromed



.01.38 Ramato lucido
Shiny Copper

1510

1 kg

.01 Bianco - White

.01.25 Corpo bianco con particolare dorato satinato - Body white with detail satin gold

.01.31 Corpo bianco con particolare cromato - Body white with detail chromed

.01.38 Corpo bianco con particolare ramato lucido - Body white with detail shiny copper

7W GU10 LED DIM (art. 0104/16)

7W GU10 LED (art. 0094/16)

50W GU10 (art. 0072)

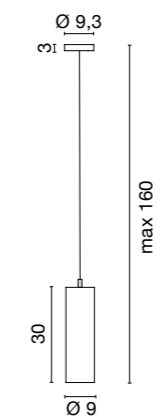

Lampada da parete o soffitto in alluminio verniciato con sorgente COB LED ed alimentatore integrato.
Versione a parete disponibile nelle finiture: bianco , sabbia, nero nero/foglia oro, bianco/foglia oro, cromo/bianco, oro satinato/bianco e bianco/fucsia. Versione a soffitto in bianco o nero.

Wall lamp in painted aluminum fitted with COB LED light engine and converter on board.
Available in following finishes: white, sand, black, black/gold leaf, white/gold leaf, chrome/white, satin gold/white and white/fuchsia. Suspension in black or white.

Applique ou plafonnier en aluminium verni avec source de lumière COB LED et alimentation intégrée.
Applique disponible dans les finitions: blanc, sable, noir, noir/feuille d'or, blanc/feuille d'or, chromé/blanc, or satiné/blanc ou blanc/fuchsia. Suspension en blanc ou noir.

Wand- oder Deckenleuchte aus lackiertem Aluminium Die Leuchte ist bestückt mit COB LED und integrierter Konverter.
Wandleuchte erhältlich in folgenden Ausführungen: Weiß, Sand, schwarz, Schwarz/Goldblatt, weiß/Goldblatt, Verchromt/weiß, satiniertem Gold/weiß, weiß/Fuchsia.

Lámpara de pared o de techo en aluminio pintado equipada con fuente de luz COB LED y convertidor integrado.
Versiones pared disponibles en los siguientes acabados: blanco, arena, negro, negro/hoja de oro, blanco/hoja de oro, cromado/blanco, oro satinado/blanco y blanco/fucsia.

Настенный или потолочный светильник из окрашенного алюминия со светодиодом на плате и встроенным драйвером.
Настенный есть с такими отделками: белый, песочный, черный, черный/сусальное золото, белый/сусальное золото, хром/белый, белый/фуксия.
Потолочный белый или черный.



AleaLED
design ABS Studio
2015



.01 Bianco
White



.01.11 Bianco / interno rosa
Out white / in pink



.01.30 Bianco / interno foglia argento
Out white / in silver leaf



.35 Sabbia
Sand



.02.29 Nero / interno foglia oro
Out black / in gold leaf



.25.01 Oro spazzolato / bianco
Out satin gold / in white



.31.01 Cromato / interno bianco
Out chromed / in white



.02.01 Nero / interno bianco
Out black / in white

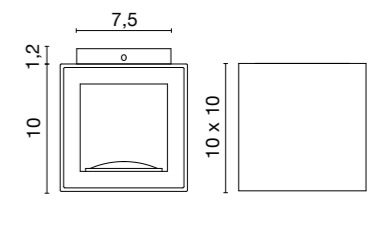
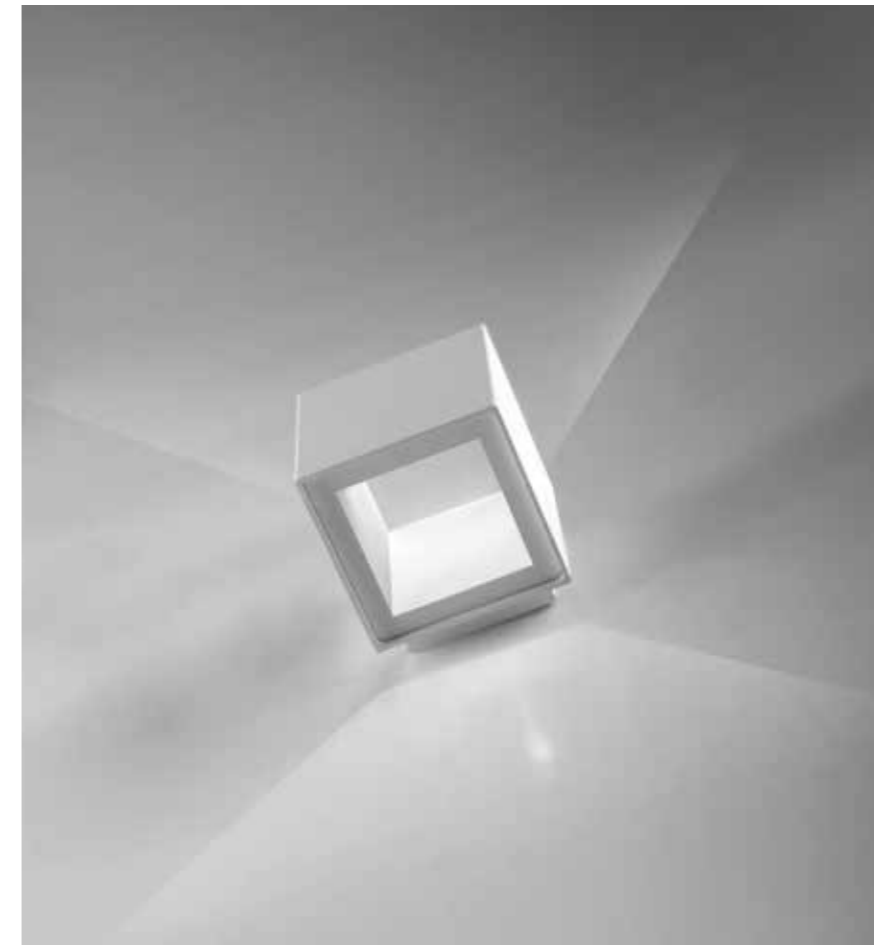

4561

0,70 kg

.01	Bianco - White
.01.11	Bianco / interno rosa - Out White / in pink
.01.30	Bianco / interno foglia argento - Out White / in silver leaf
.02.01	Nero / interno bianco - Out black / in white
.02.29	Nero / interno foglia oro - Out black / in gold leaf
.25.01	Dorato satinato/interno bianco - Out satin gold / in white
.31.01	Cromato lucido/interno bianco - Out chromed / in white
.35	Verniciato sabbia - Painted sand finishing

/W LED 6,5W 865lm 4000K

/WW LED 6,5W 844lm 3000K

/XW LED 6,5W 825lm 2700K

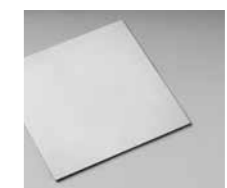
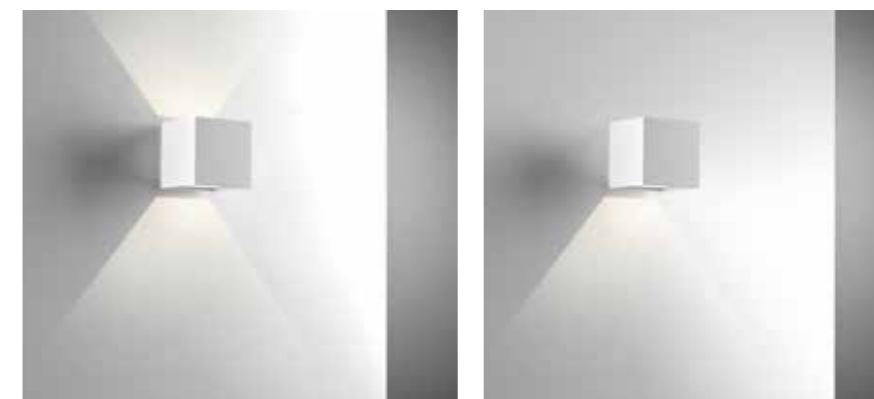

Art. 0182 .01-.02-.35
schermo per luce
monodirezionale
Screen for single side
light

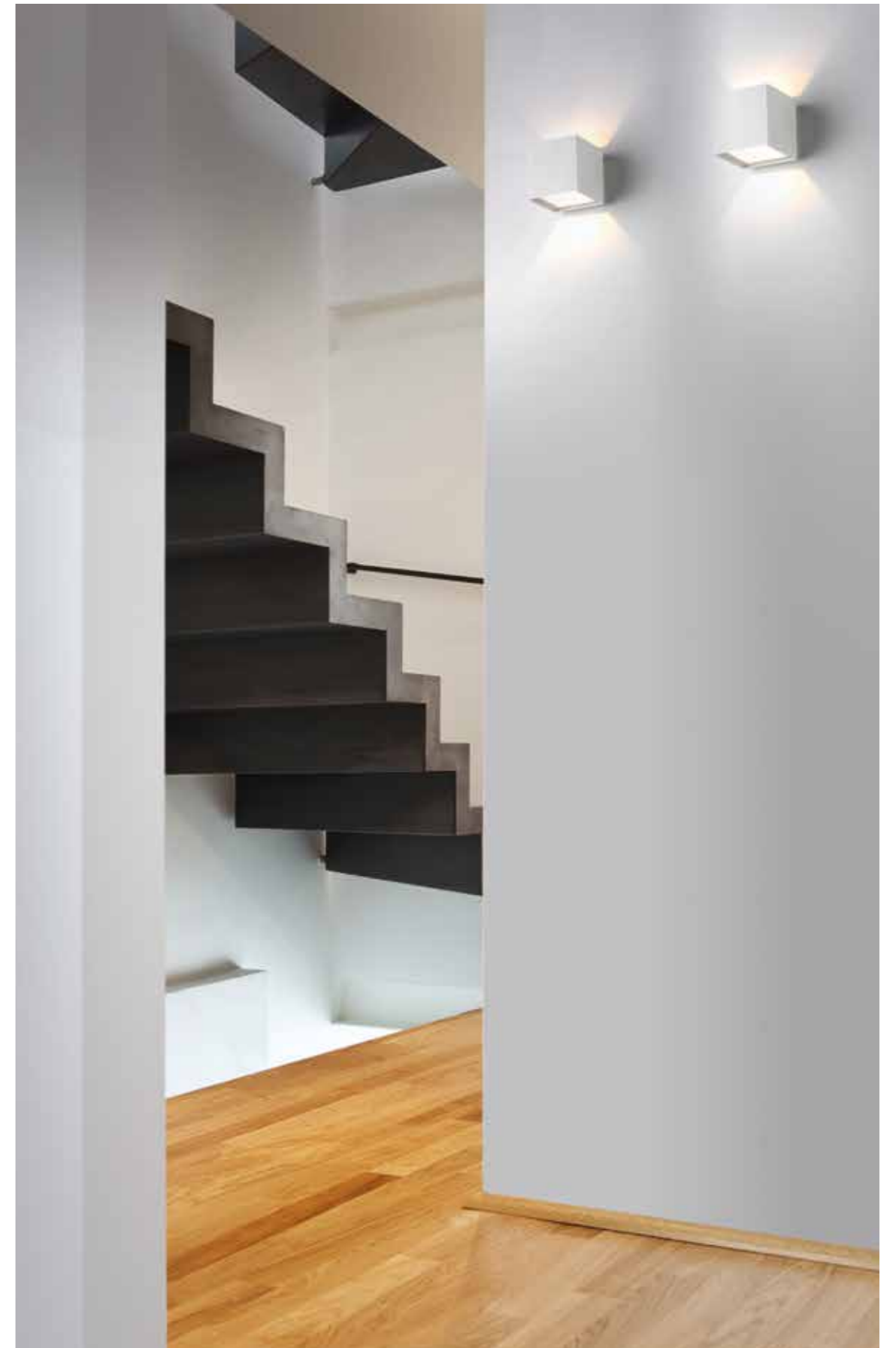
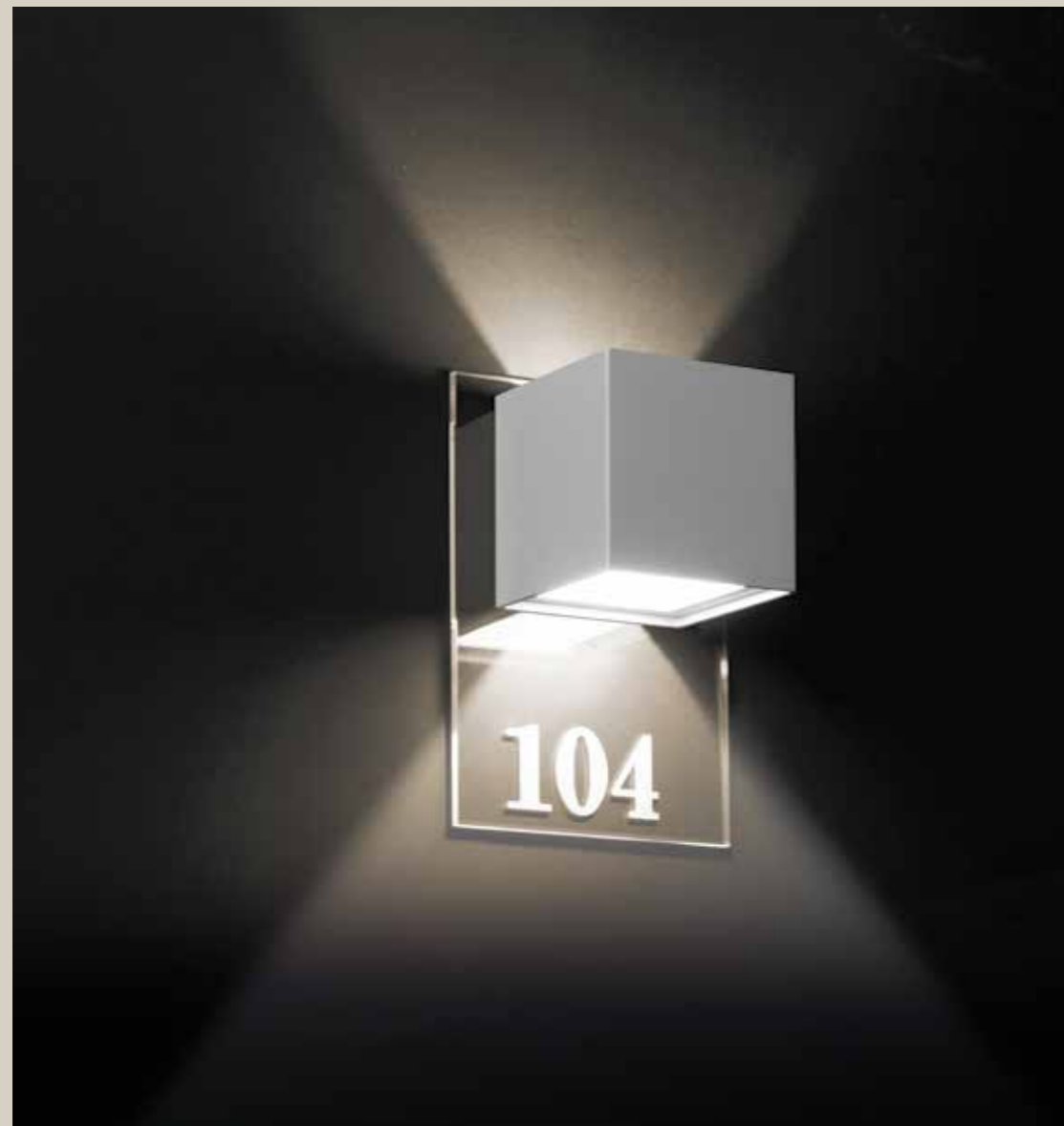



5561 0,70 kg

.01 Bianco - White

.02 Nero - Black

/W LED 6,5W 865lm 4000K

/WW LED 6,5W 844lm 3000K

/XW LED 6,5W 825lm 2700K

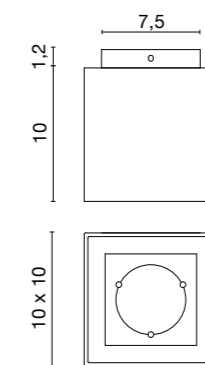



5513 1,30 kg

.01 Bianco - White

/W LED 9,8W 1210lm 4000K

/WW LED 9,8W 1111lm 3000K

/XW LED 9,8W 1085lm 2700K

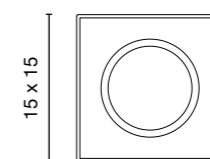

Lampade da parete orientabili (360°), soffitto o sospensione. Corpo in alluminio anodizzato o verniciato bianco; oppure vetro bianco satinato. Per le versioni in alluminio, una serie di schermi opzionali permette di ottenere svariati effetti luminosi. Sospensione con elemento di decentramento incluso 0532.

Swiveling wall lamp (360°), ceiling or suspension. Body in anodized or white painted aluminum; or in white satin glass. Aluminum models can be accessorized with a series of screens to provide different light effects. Suspension are supplied with displacement component 0532.

Applique pivotante (360°), plafonniers ou suspension.
Corps en aluminium anodisé ou verni blanc, ou bien en verre blanc satiné.
Les versions en aluminium peuvent être équipés avec des écrans pour donner différents effets de lumière. La suspension est livrée avec élément de déplacement 0532.

Decken- oder Wandleuchten (Drehbarkeit 360°). Körper aus Aluminium eloxiert oder weiß lackiert; oder mit Diffusor aus Opalglas. Für die Aluminiumversionen sind Vorsätze zur Erzielung von Lichteffekten als Zubehör erhältlich. Pendelversionen mit Umlenkelement 0532.

Lamparas de pared ajustables (360°), de pared, techo o colgantes, de aluminio anodizado o pintado blanco; vidrio blanco satinado, negro, o metalizado como uno espejo. Pantallas opcionales para variados efectos luminosos por las versiones en aluminio. Elemento para desplazar incluido en la colgante 0532.

Ориентируемый (на 360 градусов) настенный, потолочный или подвесной светильник из анодированного или окрашенного в белый цвет алюминия. Белое сатинированное стекло. Для вариантов в алюминии дополнительные экраны дают разные световые эффекты на стене. Подвесной светильник с системой децентрализации 0532.



Alea
design ABS Studio
2007



.57 Vetro bianco - White glass



.01 Bianco - White

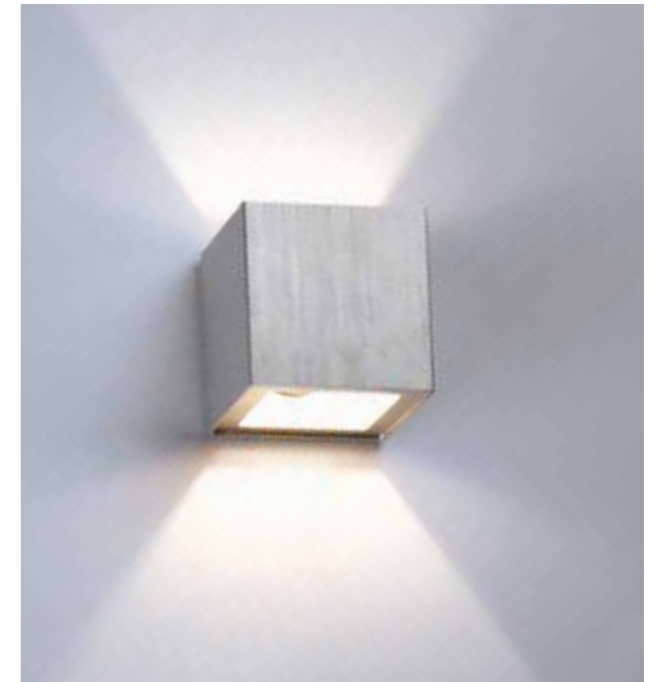

.45 alluminio anodizzato - Anodized alu

4281	0,5 kg
.01	Bianco - White
.45	Alluminio anodizzato Aluminium anodized
3,5W G9 LED (<i>art. 0092/16</i>)	
48W G9 ECO	
F	

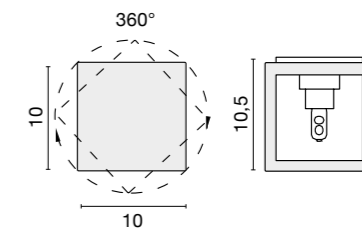

4282	0,6 kg
.57	Vetro bianco - White glass
3,5W G9 LED (<i>art. 0092/16</i>)	
48W G9 ECO	
F	

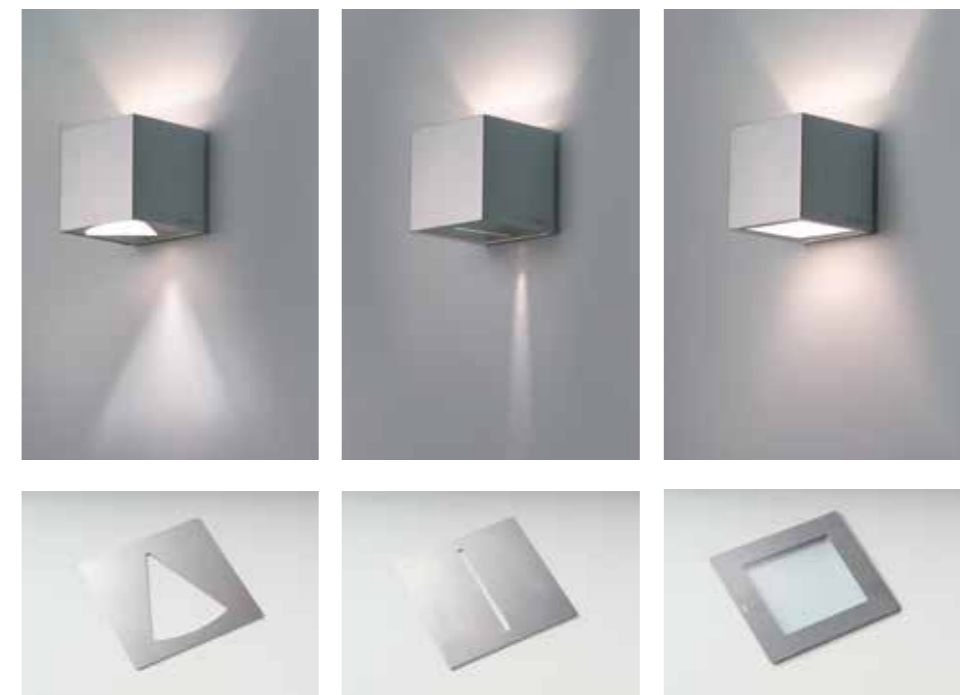
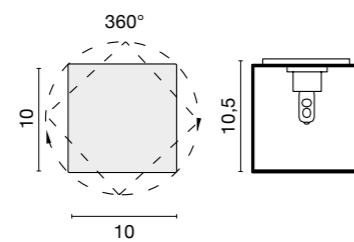

0187 .01-.45

0189 .01-.45

0205 .01-.45



1147 1,10 kg

.57 Vetro bianco - White glass

3,5W G9 LED (art. 0092/16)

48W G9 ECO

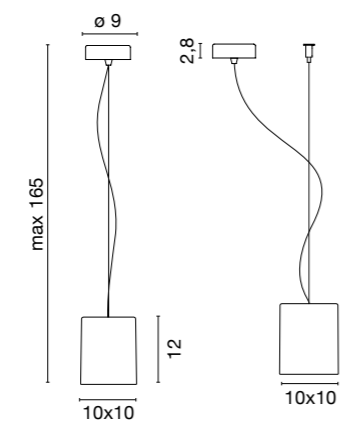

0532
Elemento
per decentramento

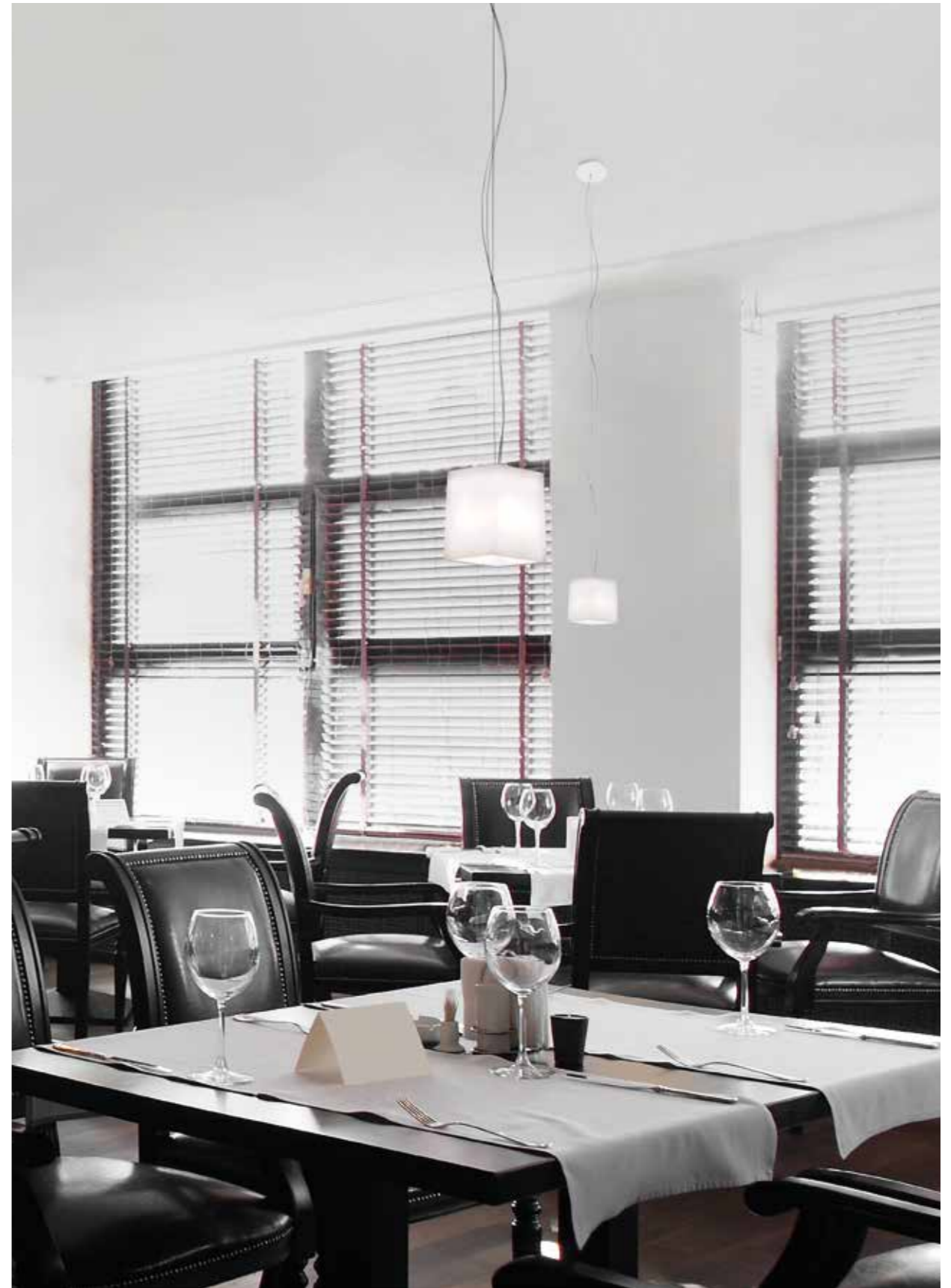

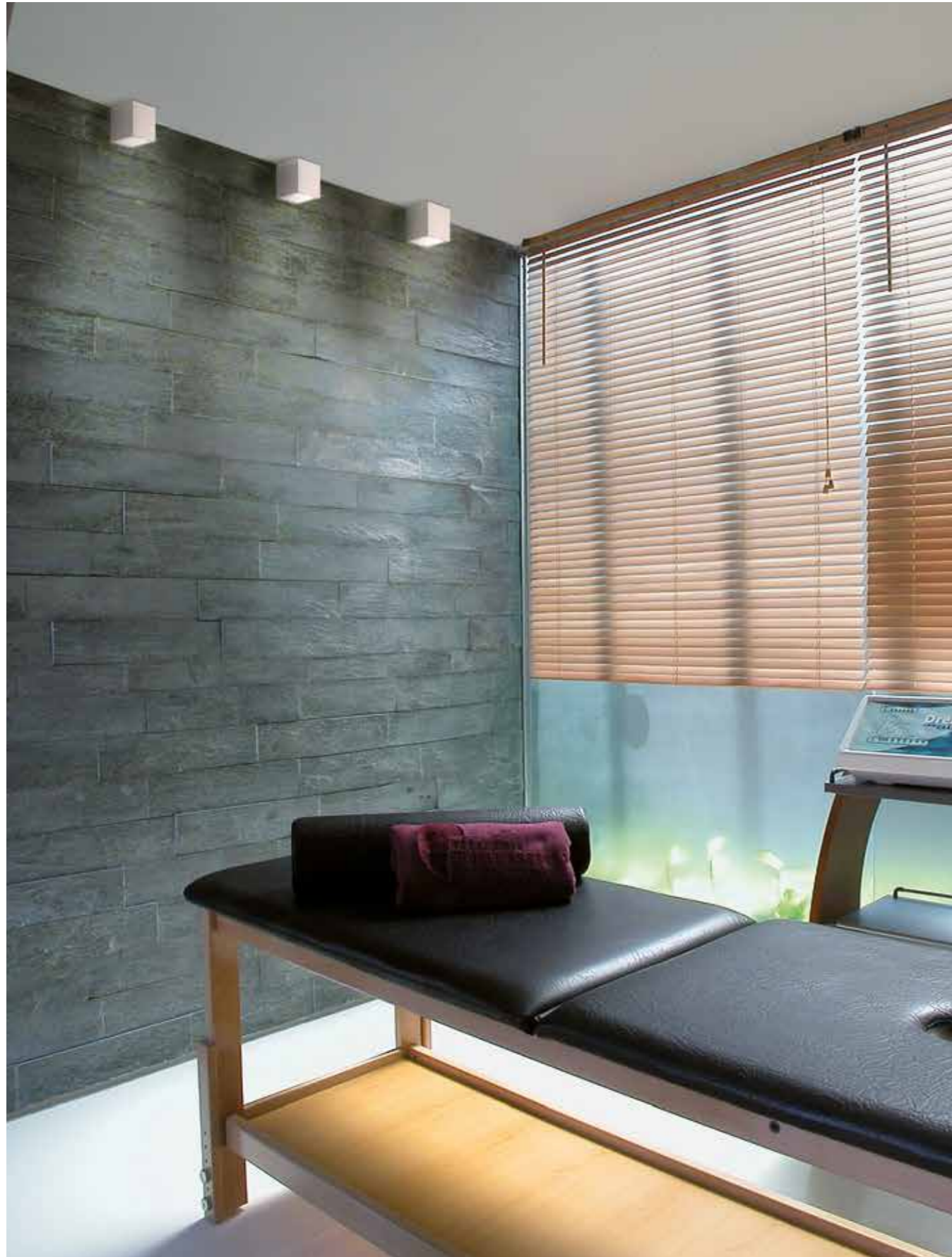

.45 alluminio anodizzato - Anodized alu



.01 Bianco - White

Art. 0205 .01 - .45
Cornice con vetro sabbato -
IP40 Per 5176 lampadina h.
max 55mm.
Frame with sandblasted glass
- IP40 For 5176 only lamp h.
max 55mm.



5176 0,5 kg

.01 Bianco - White
.45 Alluminio anodizzato
Aluminium anodized

7W GU10 LED DIM (art. 0104/16)

7W GU10 LED (art. 0094/16)

50W GU10 (art. 0072)

75W GU10

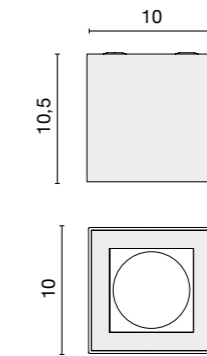

.57 Vetro bianco - White glass

5185 0,8 kg

.57 Vetro bianco - White glass

3,5W G9 LED (art. 0092/16)

48W G9 ECO

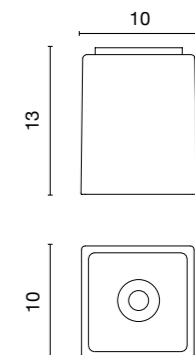

Lampade orientabili LED da tavolo parete con o senza interruttore (4540). Disponibili in bianco o con cono diffusore colorato o totalmente nera.

Adjustable table and wall lamps with or without switch (4540). Available in white, white with colored diffuser or all black.

Lampes orientables de table ou applique avec ou sans interrupteur(4540). Disponible en blanc, en blanc avec diffuseur en couleur ou tout noir.

Verstellbare Tisch- oder Wandleuchten mit oder ohne Schalter(4540). Ausführung weiß, weiß mit farbige Kopf oder komplett Schwarz.

Lámparas de mesa o pared orientables con o sin interruptor(4540). Acabado blanco, blanco con difusor coloreado o todo negro.

Поворотный настенный и настольный светильник с выключателем или без него (4540).
В белом цвете или в белом цвете с цветным абажуром или полностью черный.





.01 Bianco - White



.02 Nero - Black



.06 Verde - Green



.09 Arancio - Orange



.10 Azzurro - Light blue



.11 Rosa - Pink



4501 0,30 kg

- .01** Bianco - White
- .02** Nero - Black
- .06** Verde - Green
- .09** Arancione - Orange
- .10** Azzurro - Light blue
- .11** Rosa - Pink

LED 1W 113lm 3000K

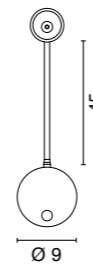
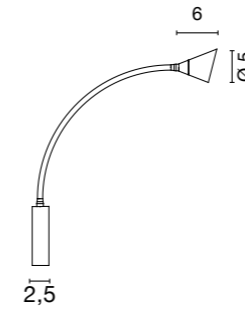

Mod. parete con interruttore
Wall model with switch



4540 Kalladue 0,30 kg

- .01** Bianco - White
- .02** Nero - Black
- .06** Verde - Green
- .09** Arancione - Orange
- .10** Azzurro - Light blue
- .11** Rosa - Pink

LED 1W 113lm 3000K

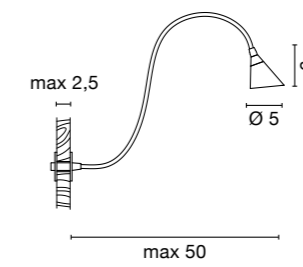

Mod. per montaggio su pannello
For mounting on panel model



4541 Kalladue 0,40 kg

- .01** Bianco - White
- .02** Nero - Black
- .06** Verde - Green
- .09** Arancione - Orange
- .10** Azzurro - Light blue
- .11** Rosa - Pink

LED 1W 113lm 3000K

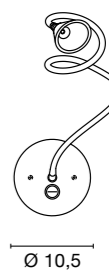
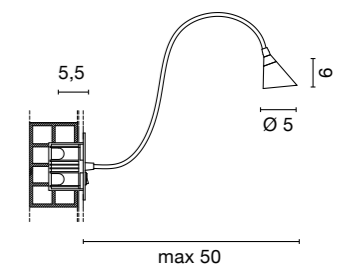

Mod. con interruttore per incasso
su parete
*Model with switch for mounting
on wall*



4541.02
Mod. parete scon interruttore
Wall model with switch

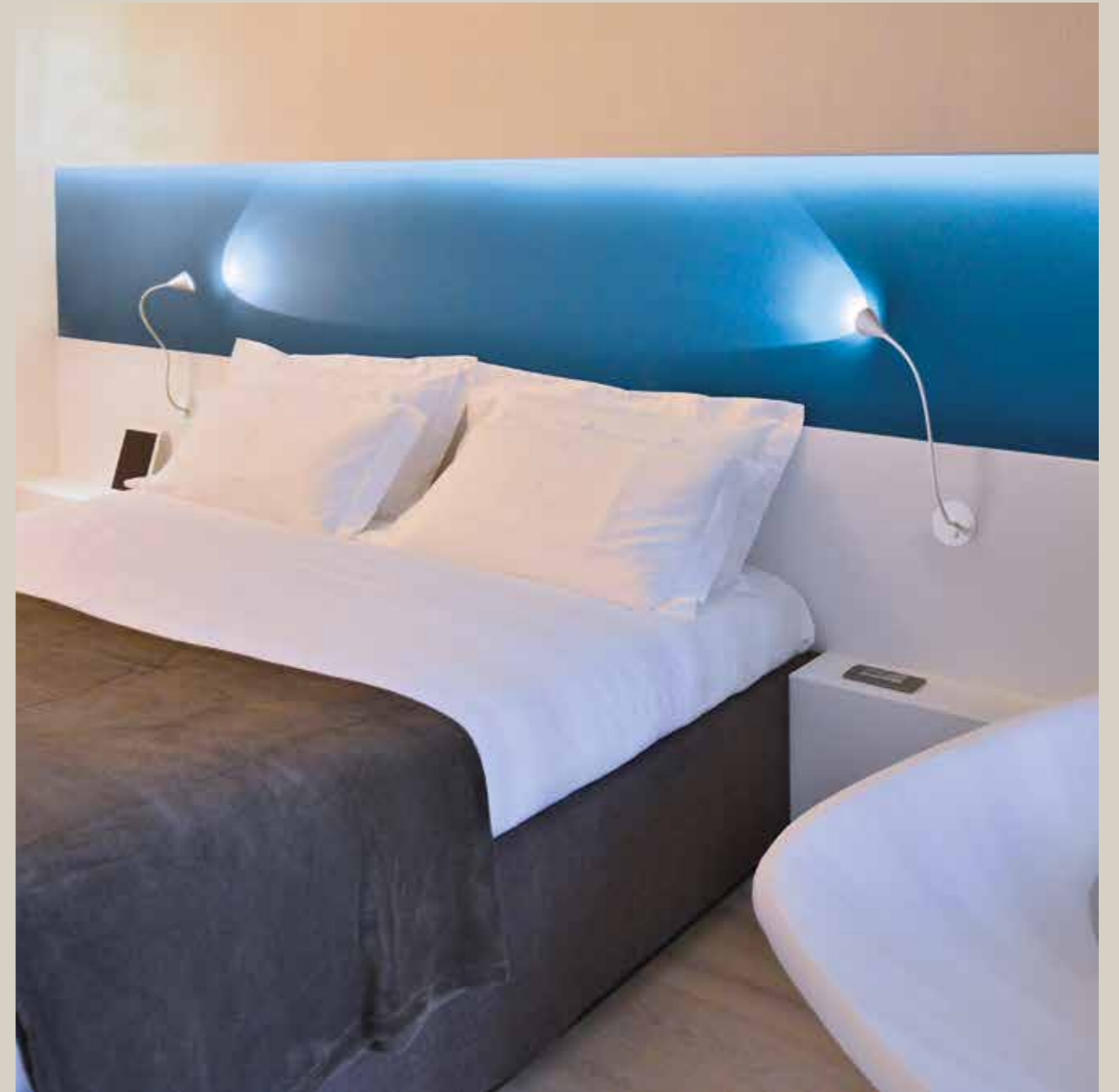

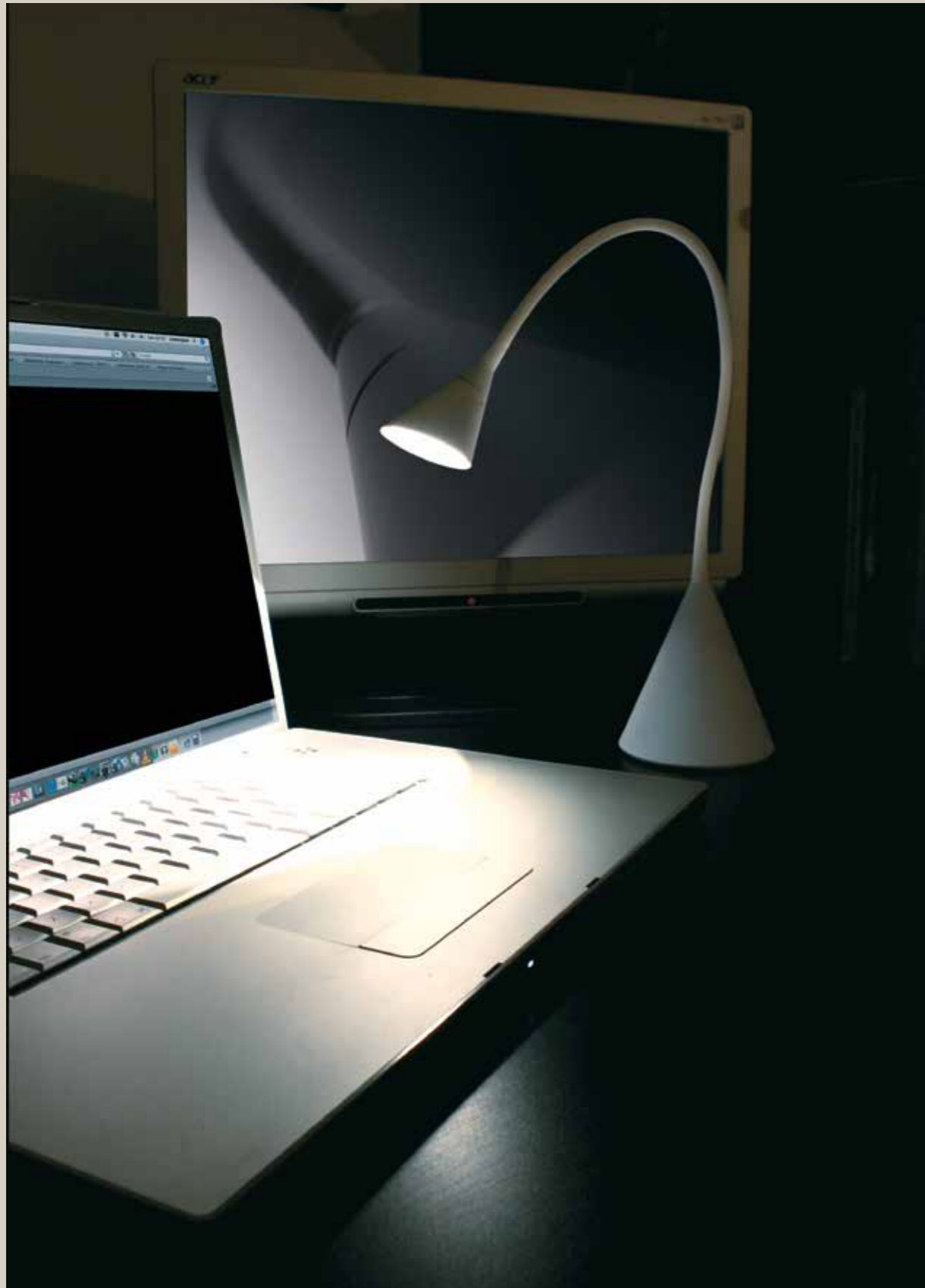

2502 0,90 kg

- .01** Bianco - White
- .02** Nero - Black
- .06** Verde - Green
- .09** Arancione - Orange
- .10** Azzurro - Light blue
- .11** Rosa - Pink

LED 1W 113lm 3000K

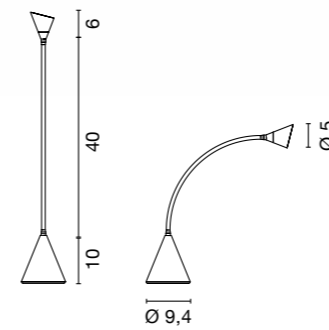

.01 **.02** **.06**



.09 **.10** **.11**

Collezione di lampade in filo di metacrilato extra-chiaro colato con tecnologia Flight-Flow.
Disponibili in versioni sospensione, tavolo, terra, parete e soffitto

Collection of lamps made of clear poured methacrylate yarn with Flight-Flow technology. Available as suspensions, table, floor, wall and ceiling.

Collection de lampes en fil de méthacrylate extra clair coulé selon la technologie Flight-Flow. Disponibles en version suspension, table, à poser, applique et plafonnier.

Kollektion Von Leuchten aus Draht aus extraklar Methacrylat verschmolzen mit Flight-Flow Technologie. Verfügbar als Pendel-, Tisch-, Boden-, Wand- und Deckenleuchte.

Colección de lamparas echas in hilo de metacrilato colado con tecnologia Flight-Flow. Disponible en version colgante, de mesa, de suelo, de techo y a pared.

Коллекция светильников, изготовленных из прозрачной метакрилатовой нити по технологии Flight-Flow. Подвесные, настольные, напольные.



Matassa
design Microsolco
2013



1517 2,20 kg

.00 Trasparente - Clear

3,5W G9 LED (art. 0092/16)

33W G9 ECO



1518 4,30 kg

.00 Trasparente - Clear

12W E27 LED (art. 0105/12)

15W E27 LED (art. 0105/15)

42W E27 ECO



1519 7,70 kg

.00 Trasparente - Clear

12W E27 LED (art. 0105/12)

15W E27 LED (art. 0105/15)

53W E27 ECO

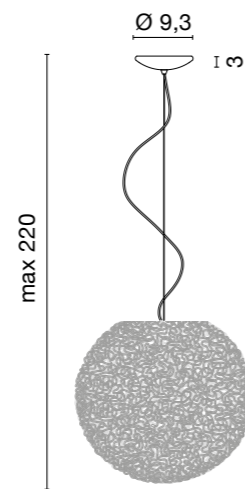

1517 Ø 23
1518 Ø 34
1519 Ø 46

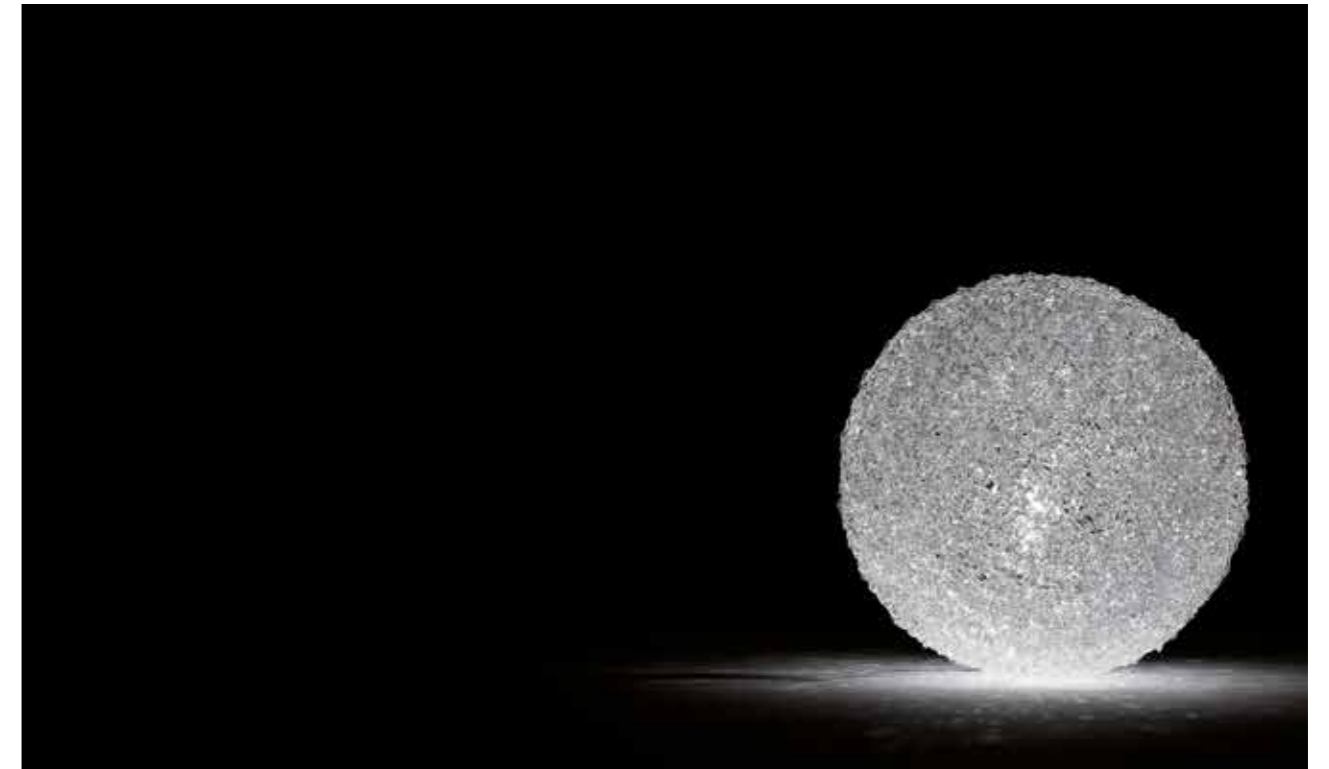

2127 2,40 kg

.00 Trasparente - Clear

3,5W G9 LED (art. 0092/16)

33W G9 ECO



2129 9 kg

.00 Trasparente - Clear

12W E27 LED (art. 0105/12)

15W E27 LED (art. 0105/15)

53W E27 ECO



2128 5,20 kg

.00 Trasparente - Clear

12W E27 LED (art. 0105/12)

42W E27 ECO



2130 25,70 kg

.00 Trasparente - Clear

12W E27 LED (art. 0105/12)

15W E27 LED (art. 0105/15)

70W E27 ECO



2127 Ø 23
2128 Ø 34

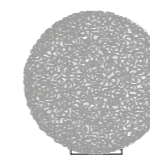

2127 Ø 8,5
2128 Ø 12

2129 Ø 46
2130 Ø 70

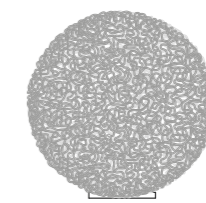

2129 Ø 14
2130 Ø 14



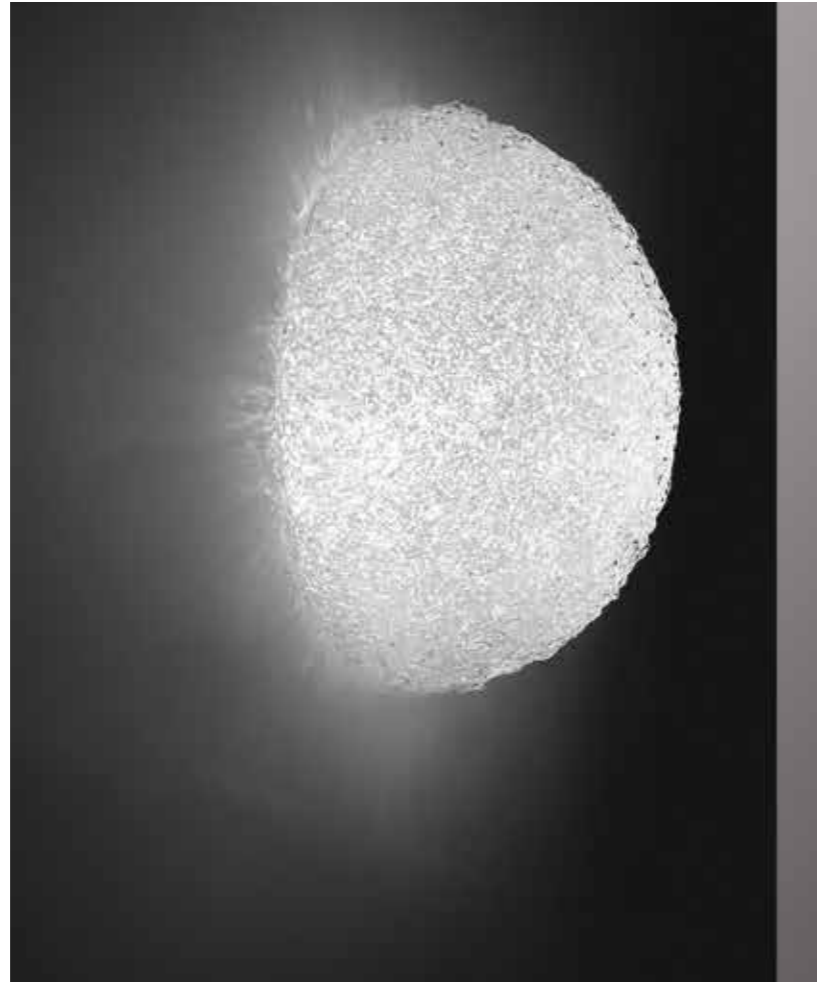

4533 2,40 kg

.00 Trasparente - Clear

12W E27 LED (art. 0105/12)

15W E27 LED (art. 0105/15)

42W E27 ECO



4534 4,80 kg

.00 Trasparente - Clear

12W E27 LED (art. 0105/12)

15W E27 LED (art. 0105/15)

53W E27 ECO

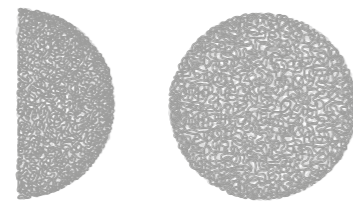

4533 17
4534 26

4533 Ø 34
4534 Ø 46

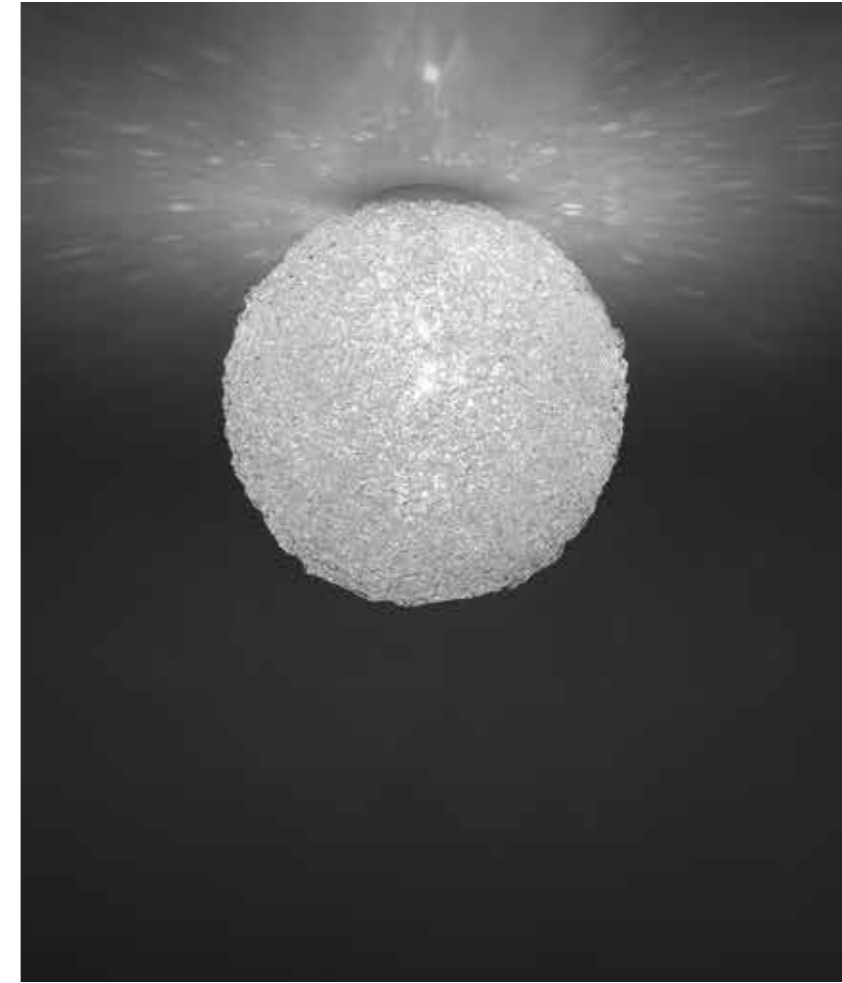

5229 2 kg

.00 Trasparente - Clear

3,5W G9 LED (art. 0092/16)

33W G9 ECO



5230 4,5 kg

.00 Trasparente - Clear

12W E27 LED (art. 0105/12)

42W E27 ECO

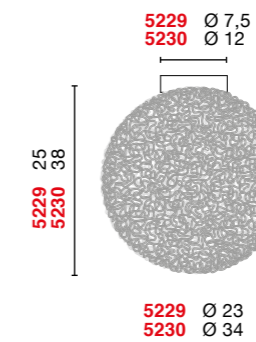



Lampada o sistema d'illuminazione a sospensione componibile. Corpi in alluminio verniciato bianco. Rosone sistema con alimentatore per max. 6 elementi.(art. 0506)

Suspension and modular lighting system. White painted aluminum body. System ceiling canopy with converter for max 6 pcs.(art. 0506)

Suspension et système d'éclairage composable suspendu. Corps en aluminium verni blanc. Rosace système avec alimentateur pour max 6 lampes (art. 0506)

Pendelleuchte sowie Modulares Beleuchtung-System zur Abhängung. Leuchtkörper aus weiß lackiertem Aluminium. System-Baldachin mit Konverter max. 6 Einheiten (art. 0506)

Colgante o sistema de iluminación modular a colgantes.Cuerpo de aluminio pintado blanco. Baldaquín sistema con convertidor hasta 6 piezas (art. 0506)

Подвесная модульная система. Корпус из алюминия,окрашенного в белый цвет. Потолочная база с конвертером для максимум 6 светильников. (арт. 0506)

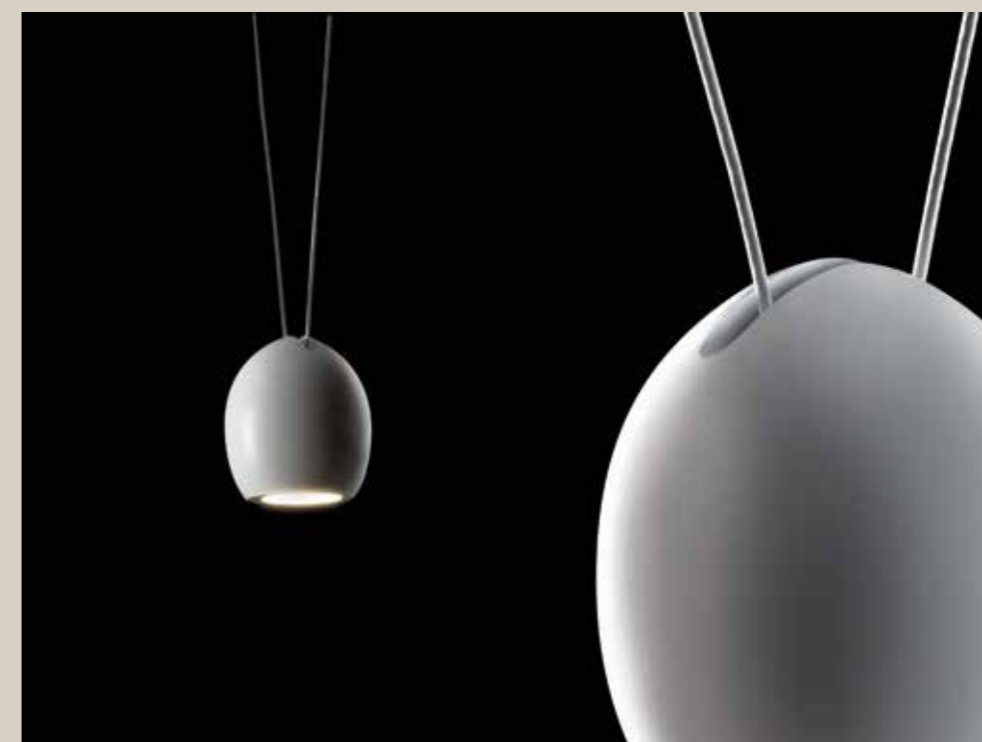

Mork
design ABS Studio
2012

Mork
design ABS Studio



Mork
design ABS Studio



1507 0,7 kg

.01 Bianco - White

LED 1050mA (3,4W) 350lm 3000K

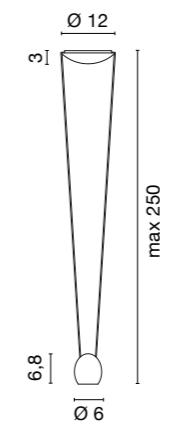

Legenda

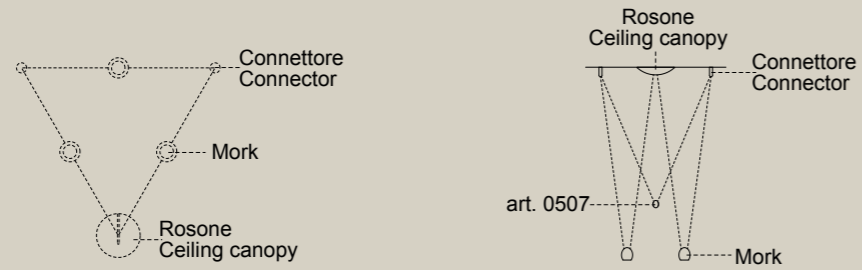

Esempi di installazione geometriche - Examples of geometric configuration

3 MORK

3 art. 1506
Mork (connector included)
+
1 art. 0506
Rosone - Ceiling canopy

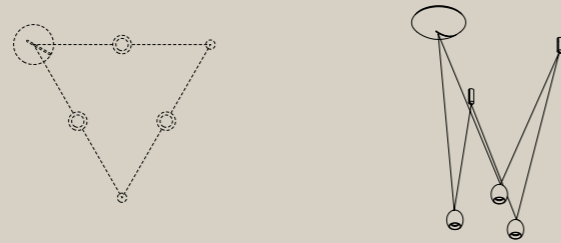

4 MORK

4 art. 1506
Mork (connector included)
+
1 art. 0506
Rosone - Ceiling canopy

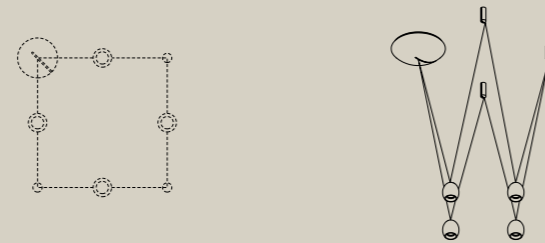

5 MORK

5 art. 1506
Mork (connector included)
+
1 art. 0506
Rosone - Ceiling canopy



6 MORK

6 art. 1506
Mork (connector included)
+
1 art. 0506
Rosone - Ceiling canopy

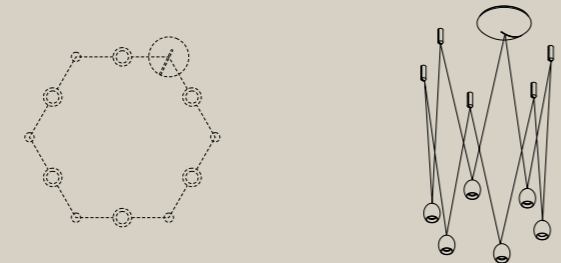

SOLO COLLEGAMENTO IN SERIE - ONLY SERIAL CONNECTION



1506 0,45 kg
.01 Bianco - White

LED max 1400 mA (4,5W) 450lm 3000K

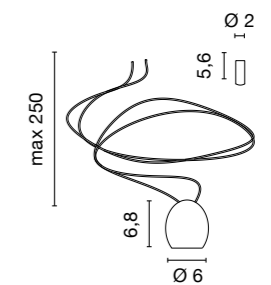

0506 0,45 kg

Rosone completo di alimentatore - max 6 Mork
Ceiling canopy with converter - max 6 Mork

.01 Bianco - White

230V

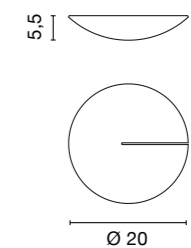

SOLO COLLEGAMENTO IN SERIE - ONLY SERIAL CONNECTION

Mork System Lineare

design ABS Studio

Esempi di installazione in linea - Examples for in linear configuration

2 MORK

2 art. 1506
Mork (connector included)
+
1 art. 0506
Rosone - Ceiling canopy
+
1 art. 0507
Collegamento per configurazioni lineari da 2,4,6 Mork.
Accessory for linear configuration
2, 4 or 6 Mork.

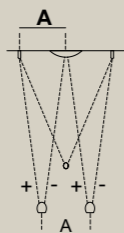

3 MORK

3 art. 1506
Mork (connector included)
+
1 art. 0506
Rosone - Ceiling canopy

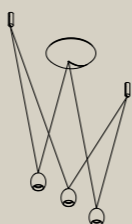
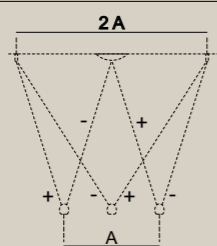

4 MORK

4 art. 1506
Mork (connector included)
+
1 art. 0506
Rosone - Ceiling canopy
+
1 art. 0507
Collegamento per configurazioni lineari da 2,4,6 Mork.
Accessory for linear configuration
2, 4 or 6 Mork.

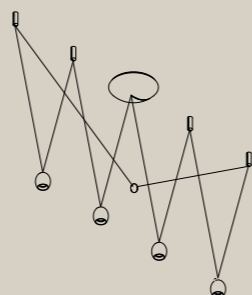
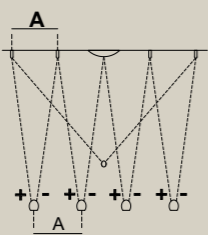

5 MORK

5 art. 1506
Mork (connector included)
+
1 art. 0506
Rosone - Ceiling canopy

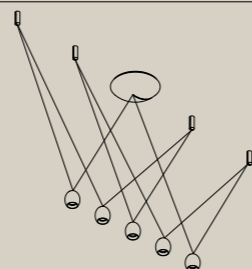
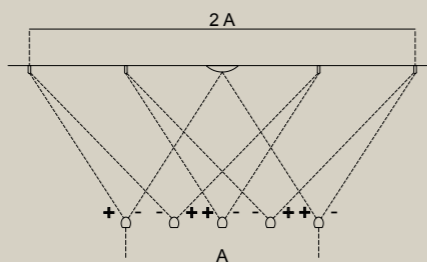

6 MORK

6 art. 1506
Mork (connector included)
+
1 art. 0506
Rosone - Ceiling canopy
+
1 art. 0507
Collegamento per configurazioni lineari da 2,4,6 Mork.
Accessory for linear configuration
2, 4 or 6 Mork.

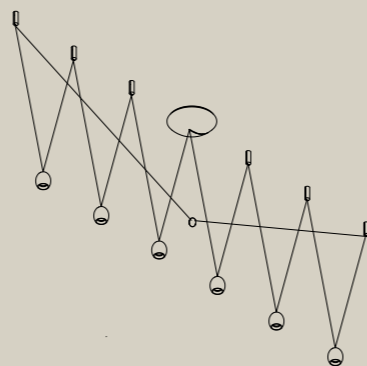
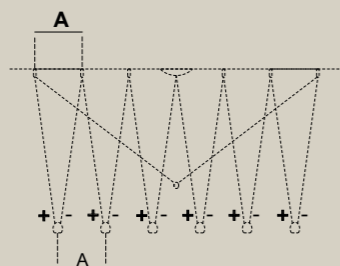

SOLO COLLEGAMENTO IN SERIE - ONLY SERIAL CONNECTION

Mork System Lineare

design ABS Studio



1506 0,45 kg

.01 Bianco - White

LED max 1400 mA (4,5W) 450lm 3000K

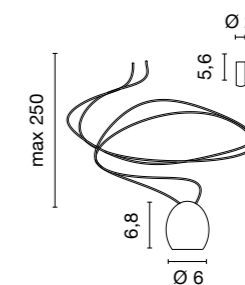
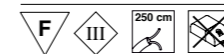

0506 0,45 kg

Rosone completo di alimentatore - max 6 Mork
Ceiling canopy with converter - max 6 Mork

.01 Bianco - White

230V



0507 0,20 kg

Collegamento per configurazioni lineari da 2, 4, 6 Mork.
Optional for linear configurations
2, 4 or 6 Mork.

.01 Bianco - White

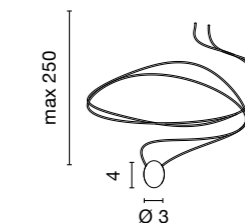

Lampade a sospensione, terra e parete in metallo con sorgente luminosa LED arretrata nel corpo lampada per garantire una luce diffusa gradevole

Suspension, Floor and wall-lamp for indirect lighting in white painted metal with recessed light source to grant a comfortable diffused light.

Suspension, lampadaire et applique pour lumière indirecte en métal verni Blanc avec source de lumière reculé pour une lumière diffuse confortable.

Stehleuchte für indirekte Beleuchtung. Gestell aus Weiß lackiertem Metall mit zurückgetretene Lichtquelle für eine angenehmes diffuses Licht.

Lámpara de pie, aplique y colgante- para iluminación indirecta de metal pintado blanco. Fuente de luz puesta arriba para una luz difusa agradable.

Подвесная, напольная и настенная лампа из окрашенного металла с утопленным в корпус источником света LED дает приятный рассеянный свет.



Baloon
design ABS Studio
2015



.01 Bianco - White



.38 Ramato Lucido - Shiny Copper



.31 Cromo - Chromed

1550 1,8 kg

.01/WW Bianco - White

.31/WW Cromato - Chromed

.38/WW Rame - Copper

LED 6,5W 844lm 3000K

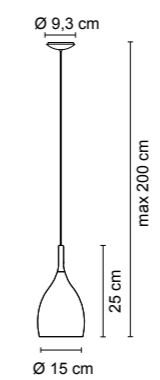



3505 4,6 kg

.01 Bianco - White

LED 17,5W 1550lm CRI > 80 3000K

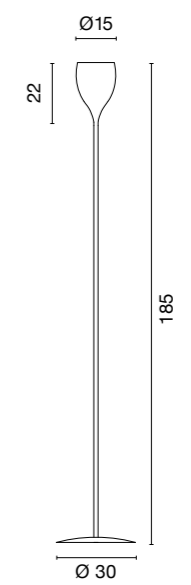
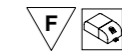



4525 2 kg
.01 Bianco - White

LED 17,5W 1550lm CRI > 80 3000K

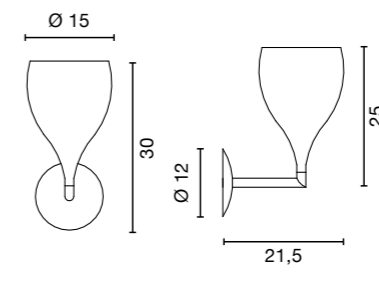

Sospensione in vetro soffiato trasparente con anello decorativo bianco. Elemento di decentramento incluso. Modulo COB LED.

Suspended lamp in transparent blown glass, decorative white ring (included). Off-center ceiling hook included. COB LED module.

Suspension en verre soufflé transparent, anneaux décoratif blanc (inclus). Élément pour déplacement inclus. Technologie COB LED.

Pendelleuchte aus transparentem geblasenem Glas, wechselbare dekorativen Ringe weiß inbegriffen. Versetzungselement inkl. COB LED Technologie.

Colgante de vidrio soplado transparente, anillos decorativos intercambiables blanco y rojo (incluidos). Elemento para desplazar incluido. Modulo COB LED.

Подвесной светильник из прозрачного дутого стекла с декоративным кольцом белого цвета. Устройство для децентрализации.



Milady
design P. Pepere
2011

Milady
design P. Pepere



Milady
design P. Pepere



1505 2,3 kg

.00 Trasparente - Clear

LED 6,5W 844lm 3000K

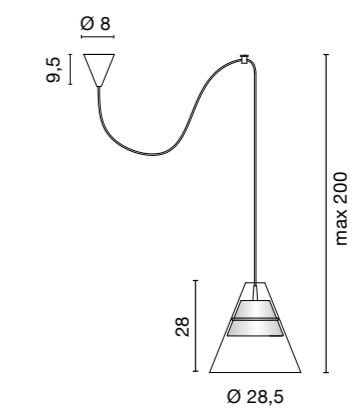

**Lampade a sospensione e a soffitto/
parete in alluminio verniciato bianco
e diffusore in metacrilato satinato
termoformato.**

**Accessorio di fissaggio in alluminio per
installazione angolata e rotazione delle
versioni parete/soffitto, art. 0172.01**

Pendant and ceiling/wall lamps in white
finished aluminum with satin thermoformed
methacrylate diffuser.

Accessory aluminum bracket allowing
angLED fixing and rotation for ceiling/wall
versions, art. 0172.01

Suspension et plafonnier/applique en alu-
minium verni blanc avec écran diffuseur en
méthacrylate satiné thermoformé.

Accessoire pivot en aluminium pour fixation
anglée et rotation des appareils applique/
plafonnier, art. 0172.01

Pendel- sowie Wand- und Deckenleuchten
aus Weiß lackiertem Aluminium. Diffusor aus
satinierem Acrylglas.

Befestigungszubehör für drehbare und
abgewinkelte Montage der Wand-/
Deckenleuchte, Art. 0172.01.

Lampara de techo/pared y colgante
de aluminio pintado blanco, difusor de
metacrilato satinado. Accesorio de anclaje
en aluminio para instalación angular y
rotación del modelo techo/pared, art.
0172.01

Подвесной и потолочный/настенный
светильники, корпус из алюминия,
окрашенного в белый цвет, рассеиватель
из термоформированного матового
метакрилата.

Как аксессуар алюминиевый поворотный
кронштейн для потолочной/настенной
модели, арт. 0172.01



Kappa
design S. Cornelissen
2015

Kappa
design S. Cornelissen



Kappa
design S. Cornelissen

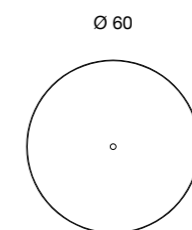
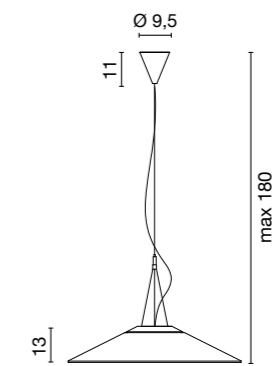

1512 4,2 kg

.01 Bianco - White

LED 28,8W 3980lm 3000K





5227.01 + 0172.01



Optional:
Accessorio di fissaggio in
alluminio per installazione
angolata e rotazione delle
versioni parete/soffitto,
art. 0172.01

Accessory aluminum bracket
allowing angLED fixing
and rotation of ceiling/wall
versions, **art. 0172.01**

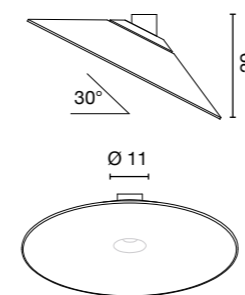

5227 3,9 kg

.01 Bianco - White

LED 28,8W 3980lm 3000K

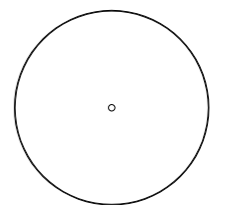
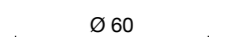
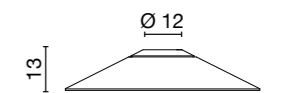
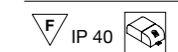

Lampade a sospensione ,a parete o soffitto in estruso d'alluminio verniciato bianco di diverse lunghezze e diffusore in metacrilato satinato .Doppia emissione disponibile nel modello a sospensione.

Suspensions and wall/ceiling lamps in white painted extruded aluminum.
Satin methacrylate diffuser. Available in different measures.
Double emission available for suspended options.

Suspensions, plafonniers et appliques en aluminium extrudé peint en blanc.
Diffuseur en méthacrylate satiné. Disponible en différentes mesures.
Double émission disponible pour les options suspendues

Pendel-, Wand- und Deckenleuchten aus weiß lackiertem Aluminium.
Diffusor aus Satin-Methacrylat. Verfügbar in verschiedenen Maßen.
Pendelleuchte sind auch mit zweiseitige Ausstrahlung verfügbar.

Colgantes, lámparas de pared y de techo de aluminio extruido pintado de blanco.
Difusor de metacrilato satinado. Disponible en diferentes medidas.
Doble emisión disponible para opciones suspendidas.

Подвесной, настенный и потолочный светильник разной длины из экструзионного алюминия, окрашенного в белый цвет. Диффузор из матового метакрилата.
В подвесном светильнике возможно направление света в две стороны.



Rail
design ABS Studio
2015



1541 1,1 kg
.01 Bianco - White

/W LED 13,5W 1800lm 4000K CRI>90
/WW LED 13,5W 1785lm 3000K CRI>90
/XW LED 13,5W 1613lm 2700K CRI>90



1542 1,5 kg
.01 Bianco - White

/W LED 27W 3600lm 4000K CRI>90
/WW LED 27W 3570lm 3000K CRI>90
/XW LED 27W 3225lm 2700K CRI>90

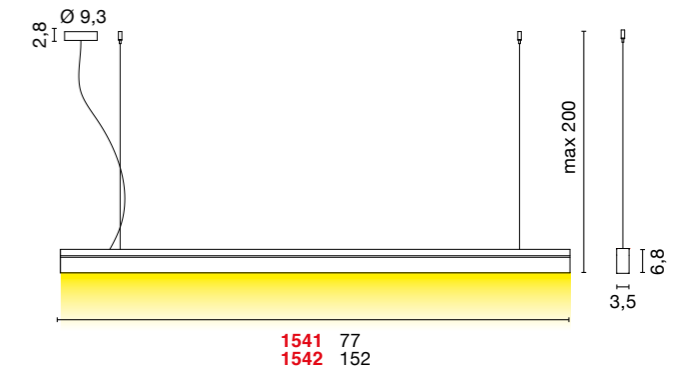

CUSTOM SIZE

Tabella lunghezze disponibili. Le misure si riferiscono alle lunghezze totali delle lampade comprese di tappi.
Table of available lengths. Measures are referred to complete fixtures including closing heads.

LED source 18W/mt CRI>90

cm.	watt	2700K (XW)	lm	3000K (WW)	lm	4000K (W)	lm
77	13,5W	1541.01/XW	1613	1541.01/WW	1785	1541.01/W	1800
102	18W	A1541.01/100/XW	2150	A1541.01/100/WW	2380	A1541.01/100/W	2400
127	22,5W	A1541.01/125/XW	2687	A1541.01/125/WW	2975	A1541.01/125/W	3000
152	27W	1542.01/XW	3225	1542.01/WW	3570	1542.01/W	3600
177	31,5W	A1541.01/175/XW	3762	A1541.01/175/WW	4165	A1541.01/175/W	4200
202	36W	A1541.01/200/XW	4300	A1541.01/200/WW	4760	A1541.01/200/W	4800
227	40,5W	A1541.01/225/XW	4837	A1541.01/225/WW	5355	A1541.01/225/W	5400
252	45W	A1541.01/250/XW	5375	A1541.01/250/WW	5950	A1541.01/250/W	6000
277	49,5W	A1541.01/275/XW	5912	A1541.01/275/WW	6545	A1541.01/275/W	6600
302	54W	A1541.01/300/XW	6450	A1541.01/300/WW	7140	A1541.01/300/W	7200

Il codice prodotto si riferisce alla lampada completa.
Rosone completo di cavo di alimentazione, 2 testate di chiusura e diffusore in policarbonato satinato sono inclusi.

*The product code refers to the complete lamp.
Ceiling rose with cable, 2 closing heads and polycarbonate satin diffuser are included.*

Rail Biemission

design ABS Studio



Rail Biemission

design ABS Studio

1545

1,3 kg

.01 Bianco - White

/W LED 37,5W 1999lm up light + 3000lm down light 4000K CRI>90

/WW LED 37,5W 1982lm up light + 2975lm down light 3000K CRI>90

/XW LED 37,5W 1791lm up light + 2687lm down light 2700K CRI>90

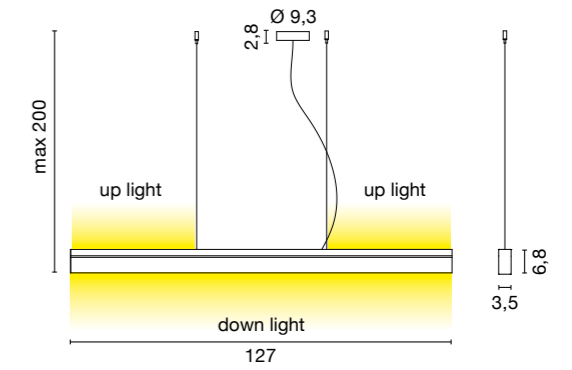

CUSTOM SIZE

Tabella lunghezze disponibili. Le misure si riferiscono alle lunghezze totali delle lampade comprese di tappi.

Table of available lengths. Measures are referred to complete fixtures including closing heads.

LED source 18W/mt CRI>90

L cm.	watt	2700K (XW)		3000K (WW)		4000K (W)	
		Im up	Im down	Im up	Im down	Im up	Im down
127	37,5W	1545.01/XW	1791 2687	1545.01/WW	1982 2975	1545.01/W	1999 3000
152	45W	A1545.01/150/XW	2150 3225	A1545.01/150/WW	2380 3570	A1545.01/150/W	2400 3600
177	55,5W	A1545.01/175/XW	2866 3762	A1545.01/175/WW	3173 4165	A1545.01/175/W	3200 4200
202	60W	A1545.01/200/XW	2866 4300	A1545.01/200/WW	3173 4760	A1545.01/200/W	3200 4800
227	67,5W	A1545.01/225/XW	3225 4837	A1545.01/225/WW	3570 5355	A1545.01/225/W	3600 5400
252	75W	A1545.01/250/XW	3583 5375	A1545.01/250/WW	3966 5950	A1545.01/250/W	4000 6000
277	82,5W	A1545.01/275/XW	3941 5912	A1545.01/275/WW	4363 6545	A1545.01/275/W	4400 6600
302	93W	A1545.01/300/XW	4658 6450	A1545.01/300/WW	5156 7140	A1545.01/300/W	5200 7200

Il codice prodotto si riferisce alla lampada completa.

Rosone completo di cavo di alimentazione, 2 testate di chiusura e diffusore in policarbonato satinato sono inclusi.

The product code refers to the complete lamp.

Ceiling rose with cable, 2 closing heads and polycarbonate satin diffuser are included.



Monoemission



Biemission

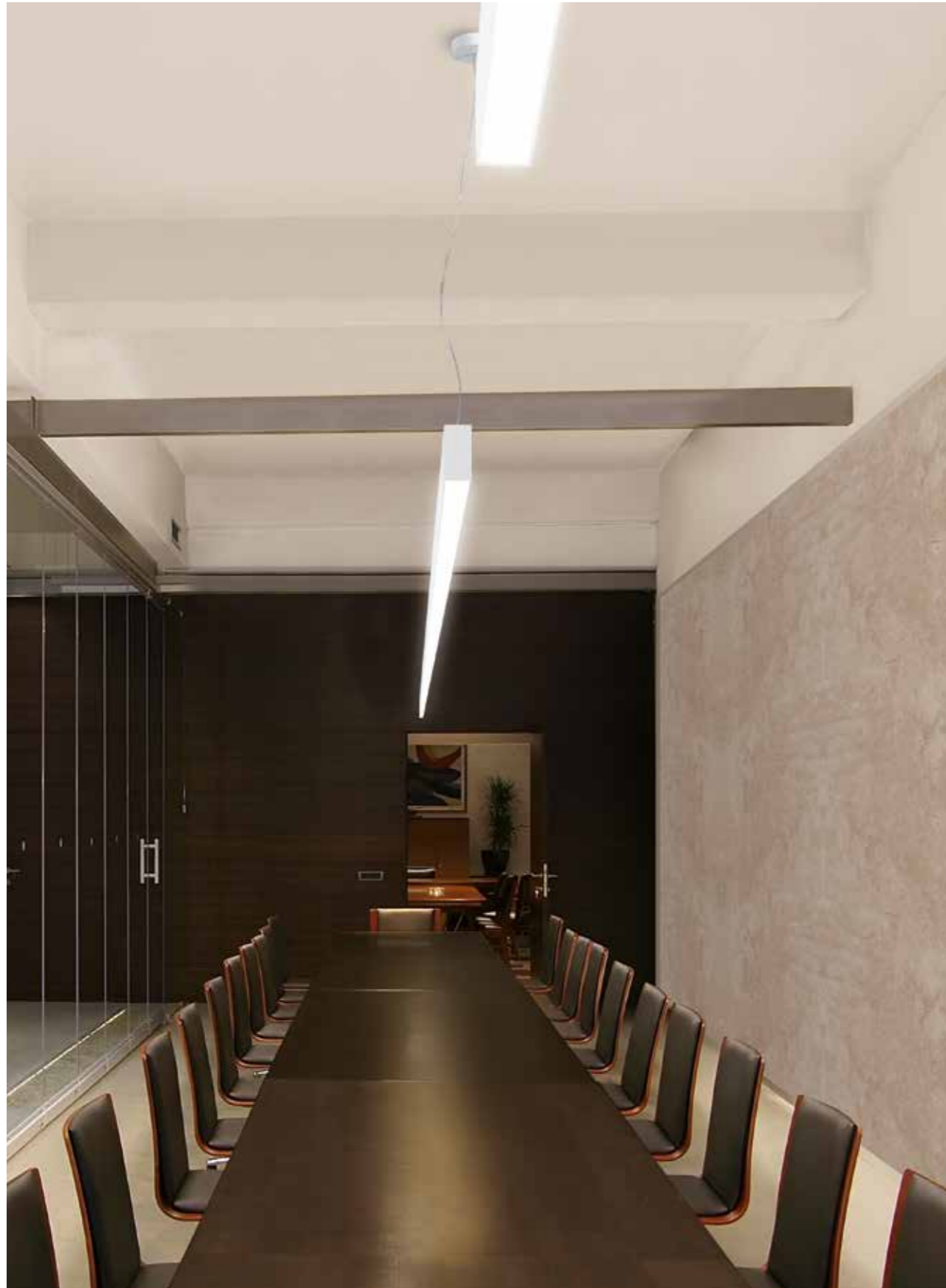

Con diffusore prismatico ad alta efficienza luminosa. Opportunamente installato garantisce UGR<19
With high efficacy prismatic diffuser. Conveniently positioned grants an UGR<19 (Unified Glare Rating)



1547 monoemission

.01 Bianco - White

/125	L. 127cm	0,8 kg
/W	LED 22,5W 3000lm 4000K CRI>90	
/WW	LED 22,5W 2975lm 3000K CRI>90	
/XW	LED 22,5W 2687lm 2700K CRI>90	

/150	L. 152cm	1,0 kg
/W	LED 27W 3600lm 4000K CRI>90	
/WW	LED 27W 3570lm 3000K CRI>90	
/XW	LED 27W 3225lm 2700K CRI>90	

/175	L. 177cm	1,2 kg
/W	LED 31,5W 4200lm 4000K CRI>90	
/WW	LED 31,5W 4165lm 3000K CRI>90	
/XW	LED 31,5W 3763lm 2700K CRI>90	

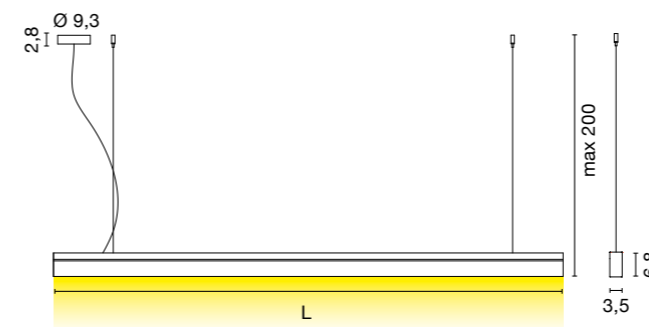

1546 biemission

.01 Bianco - White

/125	L. 127cm	0,9 kg
/W	LED 37,5W 2000lm up light + 3000lm down light 4000K CRI>90	
/WW	LED 37,5W 1983lm up light + 2975lm down light 3000K CRI>90	
/XW	LED 37,5W 1792lm up light + 2687lm down light 2700K CRI>90	

/150	L. 152cm	1,1 kg
/W	LED 45W 2400lm up light + 3000lm down light 4000K CRI>90	
/WW	LED 45W 2380lm up light + 2975lm down light 3000K CRI>90	
/XW	LED 45W 2150lm up light + 2687lm down light 2700K CRI>90	

/175	L. 177cm	1,4 kg
/W	LED 55,5W 3200lm up light + 4200lm down light 4000K CRI>90	
/WW	LED 55,5W 3173lm up light + 4165lm down light 3000K CRI>90	
/XW	LED 55,5W 2867lm up light + 3763lm down light 2700K CRI>90	

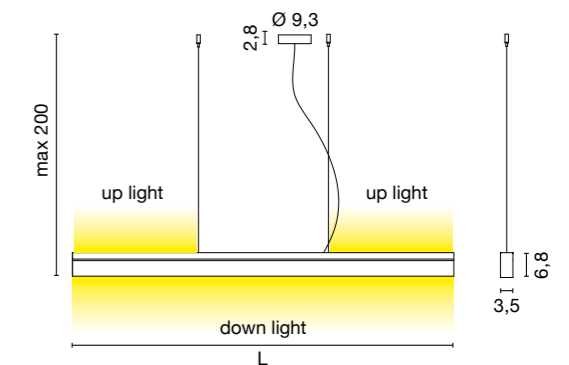



4578 1,1 kg **4579** 1,5 kg

.01 Bianco - White

.01 Bianco - White

/W LED 13,5W 1800lm 4000K CRI>90

/W LED 27W 3600lm 4000K CRI>90

/WW LED 13,5W 1785lm 3000K CRI>90

/WW LED 27W 3570lm 3000K CRI>90

/XW LED 13,5W 1613lm 2700K CRI>90

/XW LED 27W 3225lm 2700K CRI>90

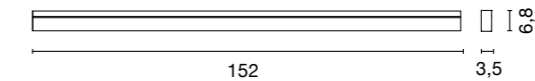
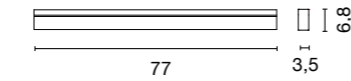
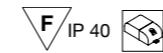

CUSTOM SIZE

Tabella lunghezze disponibili. Le misure si riferiscono alle lunghezze totali delle lampade comprese di tappi.
Table of available lengths. Measures are referred to complete fixtures including closing heads.

LED source 18W/mt CRI>90

cm.	watt	2700K (XW)	lm	3000K (WW)	lm	4000K (W)	lm
77	13,5W	4578.01/XW	1613	4578.01/WW	1785	4578.01/W	1800
102	18W	A4578.01/100/XW	2150	A4578.01/100/WW	2380	A4578.01/100/W	2400
127	22,5W	A4578.01/125/XW	2687	A4578.01/125/WW	2975	A4578.01/125/W	3000
152	27W	4579.01/XW	3225	4579.01/WW	3570	4579.01/W	3600
177	31,5W	A4578.01/175/XW	3762	A4578.01/175/WW	4165	A4578.01/175/W	4200
202	36W	A4578.01/200/XW	4304	A4578.01/200/WW	4760	A4578.01/200/W	4800
227	40,5W	A4578.01/225/XW	4837	A4578.01/225/WW	5355	A4578.01/225/W	5400
252	45W	A4578.01/250/XW	5375	A4578.01/250/WW	5950	A4578.01/250/W	6000
277	49,5W	A4578.01/275/XW	5912	A4578.01/275/WW	6545	A4578.01/275/W	6600
302	54W	A4578.01/300/XW	6450	A4578.01/300/WW	7140	A4578.01/300/W	7200

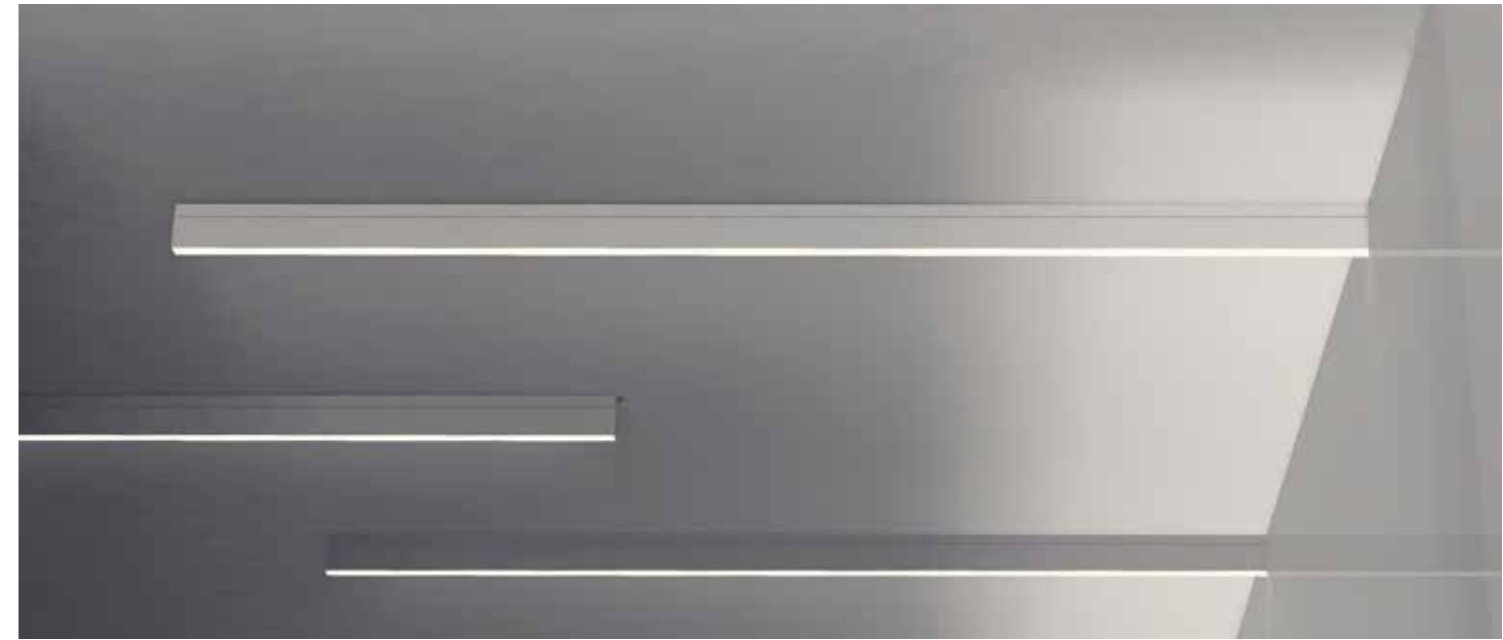

5540 1,1 kg

.01 Bianco - White

/W LED 13,5W 1800lm 4000K CRI>90

/WW LED 13,5W 1785lm 3000K CRI>90

/XW LED 13,5W 1613lm 2700K CRI>90

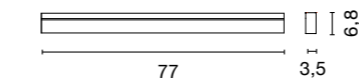

5541 1,5 kg

.01 Bianco - White

/W LED 27W 3600lm 4000K CRI>90

/WW LED 27W 3570lm 3000K CRI>90

/XW LED 27W 3225lm 2700K CRI>90

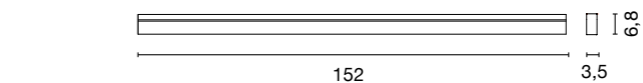

CUSTOM SIZE

Tabella lunghezze disponibili. Le misure si riferiscono alle lunghezze totali delle lampade comprese di tappi.
Table of available lengths. Measures are referred to complete fixtures including closing heads.

LED source 18W/mt CRI>90

cm.	watt	2700K (XW)	lm	3000K (WW)	lm	4000K (W)	lm
77	13,5W	5540.01/XW	1613	5540.01/WW	1785	5540.01/W	1800
102	18W	A5540.01/100/XW	2150	A5540.01/100/WW	2380	A5540.01/100/W	2400
127	22,5W	A5540.01/125/XW	2687	A5540.01/125/WW	2975	A5540.01/125/W	3000
152	27W	5541.01/XW	3225	5541.01/WW	3570	5541.01/W	3600
177	31,5W	A5540.01/175/XW	3762	A5540.01/175/WW	4165	A5540.01/175/W	4200
202	36W	A5540.01/200/XW	4304	A5540.01/200/WW	4760	A5540.01/200/W	4800
227	40,5W	A5540.01/225/XW	4837	A5540.01/225/WW	5355	A5540.01/225/W	5400
252	45W	A5540.01/250/XW	5375	A5540.01/250/WW	5950	A5540.01/250/W	6000
277	49,5W	A5540.01/275/XW	5912	A5540.01/275/WW	6545	A5540.01/275/W	6600
302	54W	A5540.01/300/XW	6450	A5540.01/300/WW	7140	A5540.01/300/W	7200

Lampade a sospensione o a soffitto, corpo in alluminio verniciato bianco, tappi in policarbonato cromato e schermo in metacrilato satinato. Ottiche speciali disponibili come accessorio (Phantom Maxi).

Suspension and ceiling lamps. White painted aluminum body, sides in chromed polycarbonate and shade in satin methacrylate. Special diffusers are available as optional (Phantom Maxi).

Suspensions et plafonniers. Corps en aluminium ,terminales en polycarbonate chromé et diffuseur en méthacrylate satiné. Diffuseurs spéciales disponibles comme accessoire (Phantom Maxi).

Pendel- sowie Deckenleuchten. Körper aus Aluminium, Seitenteile aus verchromtem Polykarbonat und Diffusor aus satiniertem Methacrylat. Sondern Diffusoren als Zubehör bestellbar (Phantom Maxi).

Lamparas de techo o colgantes, cuerpo de aluminio pintado blanco, terminales en policarbonato cromado y pantalla in metacrilato satinado. Difusores especiales disponibles como accesorios (Phantom Maxi).

Подвесной или потолочный светильник. Корпус из окрашенного алюминия, боковые детали из хромированного поликарбоната и абажур из сатинированного метакрилата. Имеются специальные диффузоры как опция (Phantom Maxi).



**Phantom
Phantom Maxi**
design ABS Studio
2014

Phantom
design ABS Studio



1524 1,5 kg

.01 Bianco - White

W LED 18,8W 2910lm 4000K

WW LED 18,8W 2770lm 3000K

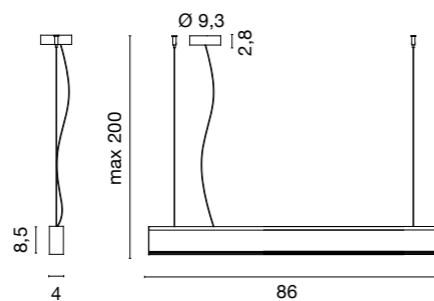

1525 1,8 kg

.01 Bianco - White

W LED 25W 3860lm 4000K

WW LED 25W 3680lm 3000K

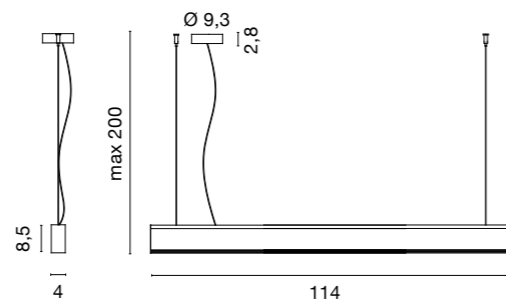
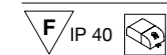

Phantom Maxi
design ABS Studio



1526 3,3 kg

.01 Bianco - White

W LED 37,5W 5790lm 4000K

WW LED 37,5W 5510lm 3000K

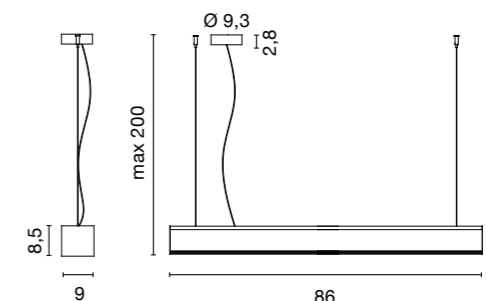

1527 4,2 kg

.01 Bianco - White

W LED 50W 7720lm 4000K

WW LED 50W 7340lm 3000K

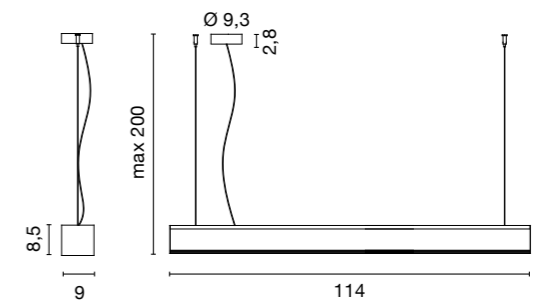
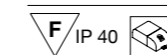

Schermo alta efficienza
High efficiency diffuser

0870/90
0870/120



5236 1,4 kg

.01 Bianco - White

/W LED 18,8W 2910lm 4000K

/WW LED 18,8W 2770lm 3000K

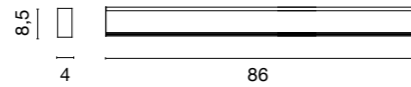

5237 1,7 kg

.01 Bianco - White

/W LED 25W 3860lm 4000K

/WW LED 25W 3680lm 3000K

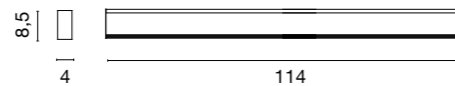
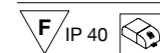

5239 2,5 kg

.01 Bianco - White

/W LED 37,5W 5790lm 4000K

/WW LED 37,5W 5510lm 3000K

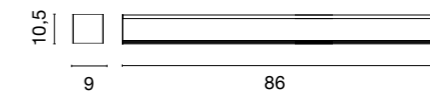

5240 4 kg

.01 Bianco - White

/W LED 50W 7720lm 4000K

/WW LED 50W 7340lm 3000K

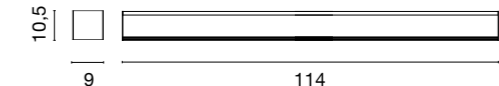

Phantom
design ABS Studio



Phantom Maxi
design ABS Studio



Lampada a sospensione in alluminio di grandi dimensioni a luce diretta.

Il portalampada con attacco E27 consente l'utilizzo di svariate sorgenti luminose.

La sua linea semplice, richiamo ai modelli classici utilizzati nell'illuminazione di capannoni e grandi spazi industriali, oggi trova utilizzo in ogni ambiente.

A richiesta sono disponibili altre finiture

Large aluminium suspension lamp for direct light. The E27 lampholder allows the use of a wide range of bulbs.

Its simple line, recall classic models used in lighting of warehouses and large industrial spaces, today it finds place in many different environments.

Other finishes are available on request.

Suspension en aluminium de grand dimensions pour lumière directe.

La douille E27 permet de choisir entre une vaste gamme d'ampoules.

Sa ligne simple, rappelle les modèles classiques utilisés dans l'éclairage d'entrepôts et de grands espaces industriels, aujourd'hui elle trouve sa place dans un nombre d'environnements différents.

D'autres finitions sont disponibles sur demande

Große Hängeleuchte aus Alu für direktes Licht. Der Lampenfassung E27 ermöglicht die Wahl von viele unterschiedlichen Leuchtmittel.

Seine einfache Linie erinnert an klassische Modelle für Beleuchtung von Lagerhallen und große Industrieflächen, heute findet es Platz in vielen verschiedenen Situationen. Andere Ausführungen sind auf Anfrage erhältlich.

Colgante de grande tamaño para luz directa.

Soporte de la lámpara E27 por una gran variedad de fuentes luminosas.

Otros acabados disponibles bajo pedido.

Подвесной металлический светильник большого размера с прямым светом. Цоколь E27 позволяет использовать разные источники света. Простые линии напоминают классические лампы, которые использовались для освещения больших складов или промышленных помещений. Сейчас такие формы применяются в разных интерьерах. По запросу возможны другие виды отделки



Pavillon
design ABS Studio
2017



.02.01 Nero / interno bianco
Out black / in white



.05.01 Rosso / interno bianco
Out red / in white



.35 Sabbia - Sand



.01 Bianco - White

1558

1,1 kg

.01 Bianco - White

.02.01 Nero / interno bianco - Out black / in white

.05.01 Rosso / interno bianco - Out Red / in white

.35 Sabbia - Sand

12W E27 LED (art. 0105/12)

21W E27 LED (art. 0105/15)

21W E27 LED (art. 0105/GLOBO)

30W E27 LED (art. 0105/30)

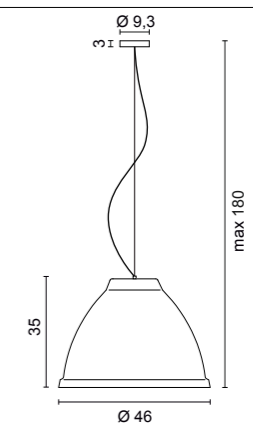



Sospensione in alluminio verniciato bianco per luce diretta e indiretta. Doppia accensione

Aluminum suspension, white finish, direct and indirect light. Double switching.

Suspension en aluminium verni blanc avec lumière directe et indirecte. Double allumage

Pendelleuchte aus weiß lackiertem Aluminium für direktes und indirektes Licht. Doppelschaltung.

Lampara colgante de aluminio pintado de blanco por luz directa y indirecta. Doble encendido

Подвесной светильник направленного и рассеянного освещения (могут включаться вместе или по отдельности), корпус выполнен из алюминия, окрашенного в белый цвет.

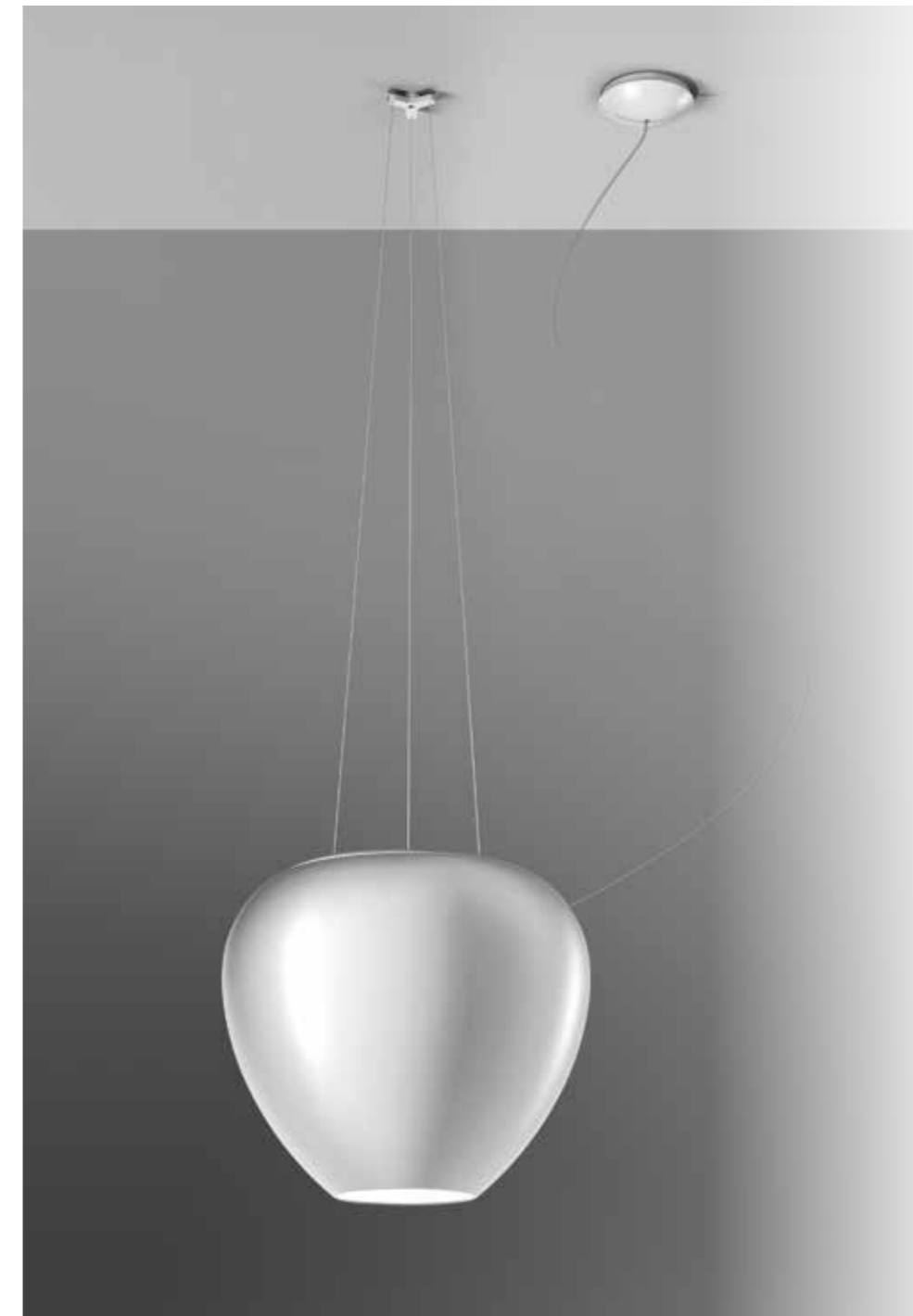

Aerostat
design C. Cornelissen
2013

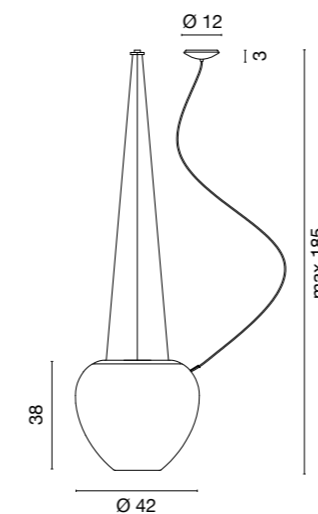

1521 4,2 kg

.01 Bianco - White

up light:
LED 17,5W 1550lm 3000K (included)

down light:
16W E27 PAR30 LED (**art. 0106**)





Sospensione in alluminio verniciato bianco a luce diffusa. Schermo diffusore in metacrilato satinato.

Aluminum suspension, white finish, direct light. Satin methacrylate diffuser.

Suspension en aluminium verni blanc avec lumière directe. Diffuser en méthacrylate satiné.

Pendelleuchte in weiß lackiertem Aluminium mit direktem Licht. Diffusor aus satiniertem Metacrylat.

Colgante de luz directa de aluminio pintado de blanco. Pantalla de metacrilato satinado.

Подвесной светильник рассеянного освещения, корпус выполнен из окрашенного алюминия. Рассеиватель из матового метакрилата.



Giara
design C. Cornelissen
2013

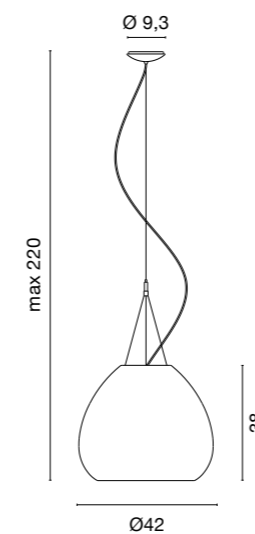

1523 3,3 kg

.01 Bianco - White

12W E27 LED (art. 0105/12)

15W E27 LED (art. 0105/15)

70W E27 ECO

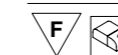



Lampade a sospensione in vetro soffiato con finitura a smalto in doppio colore.

Suspensions in blown bicolor enamelLED glass.

Lampes à suspension en verre soufflé et émaillé en double couleur.

Pendelleuchten aus geblasenem-Glas, zweifarbige Emaillierung.

Colgantes de vidrio soplado y esmaltado en doble color.

Подвесные светильники из дутого стекла, окрашенного глянцевой эмалью. С разной окраской внутри и снаружи.



Lei
design C. Cornelissen
2013

Due posizioni possibili del vetro
Two possible positioning of the glass

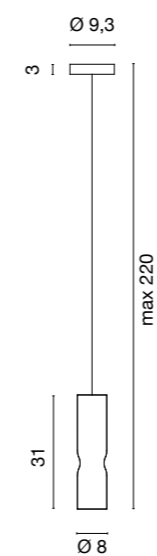

1514 0,9 kg
.01 Bianco - White
.02 Nero - Black

7W GU10 LED DIM (art. 0104/16)

7W GU10 LED (art. 0094/16)

50W GU10 (art. 0072)





Lampade a sospensione in vetro soffiato con finitura a smalto in doppio colore.
 Optional: Art. 0532: elemento per decentramento.

Suspensions in blown bicolor enamelled glass.
 Optional: Art. 0532: displacement component.

Lampes à suspension en verre soufflé et émaillé en double couleur.
 Accessoire: Art. 0532: élément pour déplacement.

Pendelleuchten aus geblasenem-Glas, zweifarbige Emaillierung.
 Zubehör: Art. 0532: Befestigung für versetzten Stromauslass.

Colgantes de vidrio soplado y esmaltado en doble color.
 Accesorio: Art. 0532: elemento para desplazar.

Подвесные светильники из дутого стекла, окрашенного глянцевой эмалью. С разной окраской внутри и снаружи.
 Как опция: система для децентрализации арт. 0532.



Lui
 design C. Cornelissen
 2013

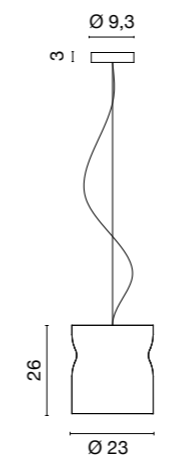

1515 2,1 kg
 .01 Bianco - White
 .02 Nero - Black

12W E27 LED (art. 0105/12)

15W E27 LED (art. 0105/15)

52W E27 ECO

F



0532
 Elemento per decentramento

Lampade a sospensione e a soffitto in vetro Pyrex trasparente con inserto bianco o nero/oro incluso. Sospensione con elemento di decentramento incluso.

Suspension and ceiling lamps in clear Pyrex glass with white or black/gold included. Suspension is including displacement component.

Suspensions et plafonniers en verre Pyrex transparent avec insert blanc ou noir/or. La suspension est livrées avec élément de déplacement.

Pendent- und Deckenleuchten in transparentem Pyrexie Glas mit einem Weißem Einsatz inbegriffen. Pendelleuchte mit Umlenkelement inbegriffen.

Colgantes y lamparas de techo de vidrio pyrex transparentes con inserte blanco o negro/ oro incluido. Lampara colgante con elemento para desplazar incluido.

Потолочные светильники из прочного боросиликатного стекла пирекс с белой вставкой. Поставляются с набором съемных декоративных аксессуаров, включая устройство для децентрализации.



Prêt a porter
design F. Rienzi
2013

Prêt a porter
design F. Rienzi



Prêt a porter
design F. Rienzi

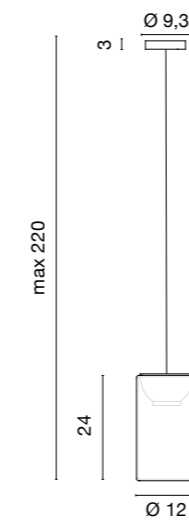

1516

1 kg

.01 Inserto bianco - White insert

.02.21 Inserto nero con interno dorato lucido - Black insert with in satin gold

12W E27 LED (art. 0105/12)



Prêt a porter
design F. Rienzi



Prêt a porter
design F. Rienzi

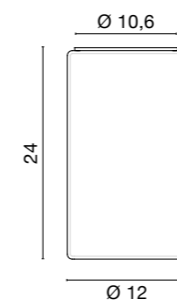

5233

1 kg

.01 Inserto bianco - White insert

.02.21 Inserto nero con interno dorato lucido - Black insert with in satin gold

12W E27 LED (art. 0105/12)



Lampade da parete orientabili (360°), soffitto o sospensione. Corpo in alluminio anodizzato o verniciato bianco; oppure vetro bianco satinato. Per le versioni in alluminio, una serie di schermi opzionali permette di ottenere svariati effetti luminosi. Sospensione con elemento di decentramento incluso 0532.

Swiveling wall lamp (360°), ceiling or suspensions. Body in anodized or white painted aluminum; or in white satin glass. Aluminum models can be accessorized with a series of screens to provide different light effects.

Suspension is supplied with displacement component 0532.

Applique pivotante (360°), plafonnier ou suspension.

Corp en aluminium anodisé ou verni blanc, ou bien en verre blanc satiné.

Les versions en aluminium peuvent être équipées avec des écrans pour plusieurs effets de lumière. La suspension est livrée avec élément de déplacement 0532.

Decken- oder Wandleuchten (Drehbarkeit 360°). Körper aus Aluminium eloxiert oder weiß lackiert; oder mit Diffusor aus Opalglas. Für die Aluminiumversionen sind Vorsätze zur Erzielung von Lichteffekten als Zubehör erhältlich. Pendelversionen mit Umlenkelement 0532.

Lamparas de pared ajustables (360°), , techo o colgantes, de aluminio anodizado o pintado blanco; vidrio blanco satinado, negro, o metalizado como uno espejo. Pantallas opcionales para variados efectos luminosos por las versiones en aluminio. Elemento para desplazar incluido en la colgante 0532.

Ориентируемый (на 360 градусов) настенный, потолочный или подвесной светильник из анодированного или окрашенного алюминия. Белое сатинированное стекло. Для вариантов в алюминии дополнительные аксессуары дают разные световые эффекты на стене. Подвесной светильник с системой децентрализации 0532.



Fokus
design ABS Studio
2006



1148 1 kg
.57 Vetro bianco - White glass

3,5W G9 LED (art. 0092/16)

48W G9 ECO

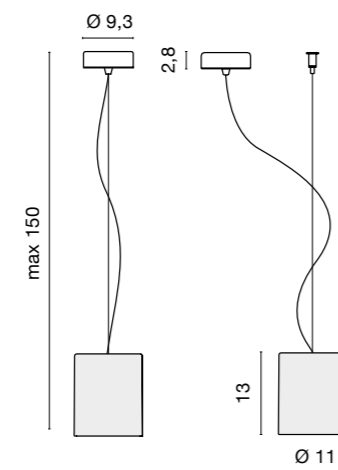

0532
Elemento
per decentramento







.57 Vetro bianco - White glass





.01 Bianco - White

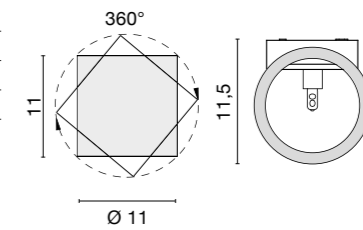

.45 alluminio anodizzato - Anodized alu

4286	0,5 kg
.01 Bianco - White	
.45 Alluminio anodizzato Aluminium anodized	
3,5W G9 LED (art. 0092/16)	
48W G9 ECO	
 	



4287	0,6 kg
.57 Vetro bianco - White glass	
3,5W G9 LED (art. 0092/16)	
48W G9 ECO	
 	

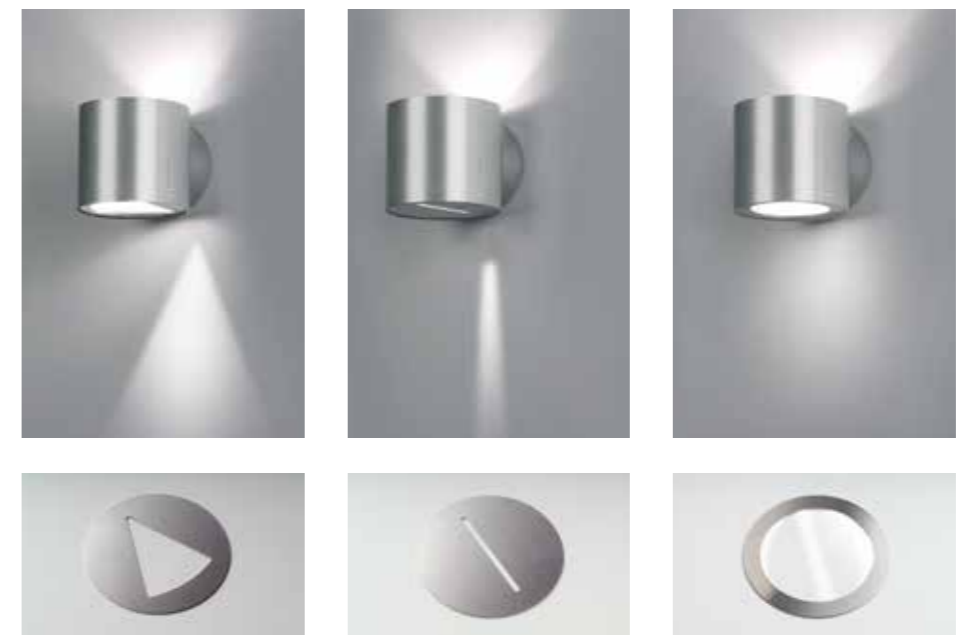
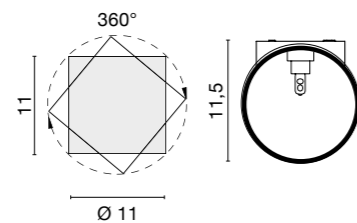

0186.01-.45

max 33W ECO

0188.01-.45

max 20W ECO

0204.01-.45

max 20W ECO



Art. 0204.01 - .45
Cornice con vetro sabbato -
IP40 Per 5174 lampadina h.
max 55mm.
Frame with sandblasted glass
- IP40 For 5174 only lamp h.
max 55mm.



5174 0,5 kg
.01 Bianco - White
.45 Alluminio anodizzato
 Aluminium anodized

7W GU10 LED DIM (art. 0104/16)
 7W GU10 LED (art. 0094/16)
 50W GU10 (art. 0072)
 75W GU10

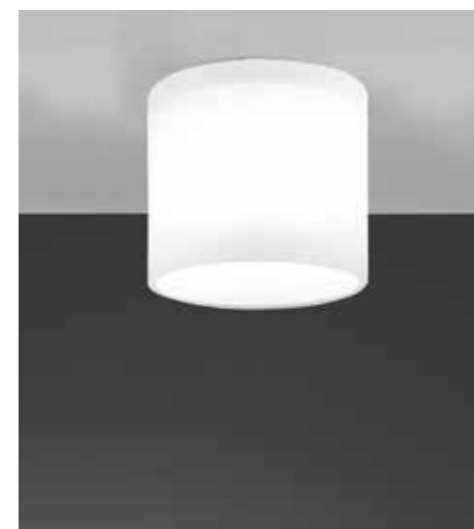
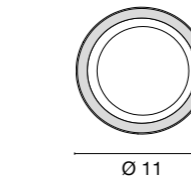

5186 0,8 kg
.57 Vetro bianco - White glass
 3,5W G9 LED (art. 0092/16)
 48W G9 ECO

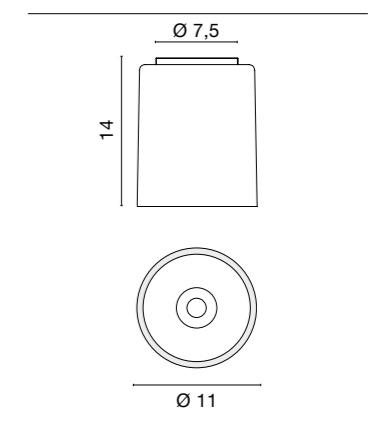

Fokus Maxi LED

design ABS Studio



Fokus Maxi LED

design ABS Studio



5514 1,10 kg

.01 Bianco - White

/W LED 9,8W 1210lm 4000K

/WW LED 9,8W 1111lm 3000K

/XW LED 9,8W 1085lm 2700K

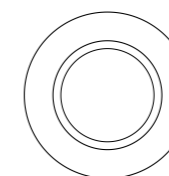
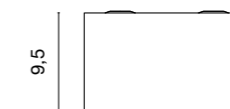

Ø 15



5539	1,50 kg
.01 Bianco - White	
AWW LED 8,7W 700lm 3000K	
F  IP65	

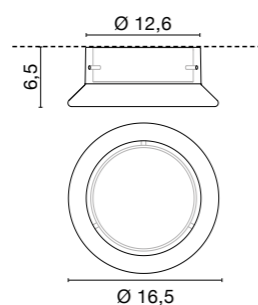

Lampada da esterno IP65 per installazione a soffitto/parete. Corpo in alluminio anodizzato e verniciato bianco, schermo in metacrilato opalino. Diffusore in vetro pressato extra-chiaro lucidato.

Ceiling/wall lamp IP65 for outdoor use. Aluminum body is anodized and white painted, opal methacrylate screen. Polished pressed extra-clear glass diffuser.

Lampe plafond/mur IP65 pour usage extérieur. Corps en aluminium anodisé et verni blanc, écran de méthacrylate opalin. Diffuseur en verre pressé poli extra-clair.

Wand- und Deckenleuchte für Außenbereiche mit Schutzart IP65. Gehäuse aus eloxiertem und weiß lackiertem Aluminium, Schirm aus opalisiertem Acrylglas. Diffusor aus Pressglas, extraklar und poliert.

Lámpara de techo/pared IP65 para exteriores. Cuerpo de aluminio anodizado y pintado blanco. Pantalla de metacrilato opalino y difusor de cristal prensado extra claro pulido.

Потолочный/настенный светильник для наружного использования IP65. Анодированный алюминий, окрашен в белый цвет. Рассеиватель из матового метакрилата. Диффузор из сверхяркого стекла.

Roc
design F. Rienzi
2016



5538 0,60 kg

.01 Bianco - White

.02 Nero - Black

.38 Ramato lucido - Shiny copper

AWW LED 8,7W 700lm 3000K

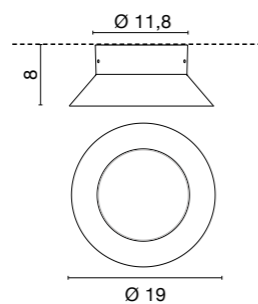

Lampada da esterno IP65 per installazione a soffitto/parete. Corpo in alluminio anodizzato e verniciato bianco, diffusore in metacrilato satinato. Riflettore in alluminio anodizzato verniciato bianco o nero oppure in rame lucidato protetto da verniciatura trasparente zapon.

Ceiling/wall lamp IP65 for outdoor use. Anodized aluminum body painted in white, satin methacrylate diffuser. Anodized aluminum reflector white or black finish, or polished copper protected with zapon clear varnish.

Lampe plafond/mur IP65 pour usage extérieur. Corps en aluminium anodisé verni blanc et diffuseur en méthacrylate satiné. Réflecteur en aluminium anodisé verni blanc ou noir, ou en cuivre dépoli protégé avec vernis transparent zapon.

Wand-/Deckenleuchte für Außenbereich mit Schutzart IP65. Gehäuse aus eloxiertem Aluminium weiß und Diffusor aus satiniertem Methacrylat. Reflektor aus eloxiertem Aluminium Ausführung weiß oder schwarz, oder aus Kupfer poliert mit farblose zapon-Lack geschützt.

Lámpara de techo/pared IP65 para exteriores. Cuerpo de aluminio anodizado pintado blanco y pantalla de metacrilato satinado. Reflector de aluminio anodizado pintado blanco o negro, o en cobre pulido protegido con barniz zapon incoloro.

Потолочный/настенный светильник для наружного использования IP65. Корпус из анодированного алюминия окрашен в белый цвет. Рассеиватель из сатирированного метакрилата. Отражатель из анодированного алюминия, окрашен в белый или черный цвет, или из полированной меди, покрытый защитным прозрачным лаком.

Jazz
design F. Rienzi
2016



5520	1,30 kg
.01	Bianco - White
.45	Alluminio anodizzato Aluminium anodized
WW	LED 10W 850lm 3000K
F	IP65

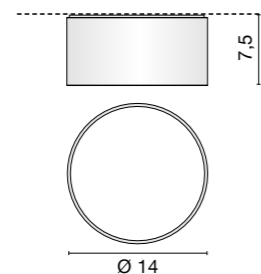

Lampada LED da plafone o parete IP65 in alluminio anodizzato (anodizzazione rinforzata per esterni) o verniciato bianco e diffusore in metacrilato. Modulo LED 10W 220-240V.

Wall or ceiling LED lamp IP 65, aluminium body in anodized (reinforced anodizing for outdoor) or white painted finish. Metachrilate diffuser. 10W LED module 220-240V.

Applique ou plafonnier LED IP 65, corps en aluminium anodisé (anodisation renforcée pour l'extérieur) ou verni blanc et diffuseur en metachrilate satiné. Module LED 10W 220-240V.

Wand- oder Deckenleuchte LED IP65, Körper aus Aluminium eloxiert (verstärktem Eloxierung für Außenbereich) oder weiß lackiert. Metakrilat Diffusor matt. LED Modul 10W 220-240V.

Lampara LED de pared y de techo IP65, estructura en aluminio anodisado (anodisacion reforzada para exterior) o pintada blanca y difusor en metacrilato satinado. Modulo LED 10W 220-240V.

Потолочный или настенный светильник со степенью защиты IP65 из алюминия с усиленным анодированием для наружного использования или окрашенный в белый цвет. Диффузор из матового метакрилата. Светодиодный модуль 10 ватт для подключения в сеть 220-240в.

Drum
design ABS Studio
2014

**Lampade LED IP44 in alluminio, diffusore in policarbonato.
Terminali in policarbonato cromato.**

LED lamps IP44 in aluminum, polycarbonate
diffuser.
Stoppers in chromed polycarbonate.

Lampes LED IP44 en aluminium, diffuseur en
polycarbonate.
Terminals en polycarbonate chromé.

LED leuchten IP44 aus Aluminium Diffusor aus
Polykarbonat.
End-Teile aus Verchromtem Polykarbonat.

Lamparas LED IP44 en aluminio y difusor en
policarbonato.
Terminales de policarbonato cromado.

Настенные или потолочные лампы из
алюминия, диффузор из поликарбоната.
Кронштейны из хромированного
поликарбоната.



Morning LED
design P. Peperè
1997

Morning LED

design P. Pepere



Morning LED

design P. Pepere



4597 0,70 kg

.31 Cromato - Chromed

/W LED 6,25W 980lm 4000K

/WW LED 6,25W 930lm 3000K

F  IP44

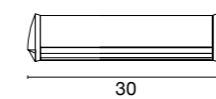

30

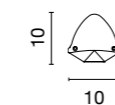

10

4598 1,30 kg

.31 Cromato - Chromed

/W LED 12,5W 1930lm 4000K

/WW LED 12,5W 1840lm 3000K

F  IP44



60

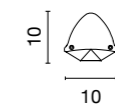

10

Lampada LED IP44 da parete o soffitto in alluminio con diffusore in policarbonato. Terminali in policarbonato cromato.

Wall/ceiling LED lamp IP44, aluminum body, Polycarbonate diffuser and chromed polycarbonate end-pieces.

Lampe LED pour mur/plafond IP44, corps en aluminium, diffuseur en polycarbonate et terminales en polycarbonate chromé

Wand- /Decken-LED-Lampe IP44, Aluminiumgehäuse, Polycarbonat-Diffusor und verchromte Endstücke aus Polycarbonat.

Lámpara LED de pared/techo IP44, cuerpo de aluminio, difusor de policarbonato y terminales de policarbonato cromado.

Светодиодный настенный светильник из алюминия, диффузор из поликарбоната. Степень защиты IP44. Заглушки из хромированного поликарбоната.









Siba LED
design P. Pepere
2009

Siba LED
design P. Pepere

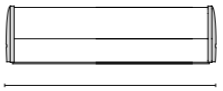
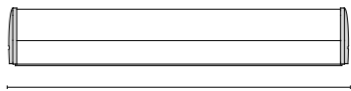

Siba LED
design P. Pepere



4331	0,70 kg	4333	1,10 kg
.31 Cromato - Chromed		.31 Cromato - Chromed	
/W LED 6,25W 980lm 4000K		/W LED 12,5W 1930lm 4000K	
/WW LED 6,25W 930lm 3000K		/WW LED 12,5W 1840lm 3000K	
F  IP44		F  IP44	
			
33		60	
			
10		10	
			
5,5		5,5	

Soluzioni luminose che utilizzano come elemento decorativo delle lampadine a filamento LED in vetro soffiato. Le lampadine dimmerabili sono disponibili in due potenze, 5W e 11W, e sono caratterizzate da forme, colori e dimensioni diverse. L'effetto fumé o retrò conferiscono a UNIDEA quel surplus di eleganza evocativa ed emozionale che rende unico un progetto luminoso. Le composizioni si completano con diversi accessori che consentono la personalizzazione del sistema.

Lighting solutions using blown glass filament LED bulbs as a decorative element. Dimmable light bulbs are available in two powers, 5W and 11W, and are characterized by different shapes, colors and sizes. The smoky or retrò effect provides to UNIDEA a surplus of evocative and emotional elegance that makes a luminous project unique. The compositions are completed with different accessories the customization of the system.

Solutions d'éclairage utilisant comme élément décoratif des ampoules LED à filament en verre soufflé. Les ampoules dimmables sont disponibles en deux puissances, 5W et 11W, et sont caractérisées par différentes formes, couleurs et tailles. L'effet fumé ou retrò apporte à UNIDEA un surplus d'élégance évocatrice et émotionnelle qui rend unique un projet lumineux. Les compositions sont complétées avec différents accessoires de personnalisation du système.

Beleuchtungslösungen die benutzen LED-Leuchtfaden-Birnen aus geblasenem Glas als dekoratives Element. Dimmbare LED-birnen sind in zwei Wattzahlen verfügbar, 5W und 11W, erhältlich und zeichnen sich durch unterschiedliche Formen, Farben und Größen aus. Der Rauch- oder Antik-Effekt verleiht der UNIDEA einen Überschuss an evokativer und emotionaler Eleganz, die ein leuchtendes Projekt einzigartig macht. Verschiedene Zubehöre stehen zur Verfügung zur Personalisierung des Systems.

Soluciones de iluminación con bombillas LED de filamento de vidrio soplado como elemento decorativo. Las bombillas dimmables están disponibles en dos potencias, 5W y 11W, y se caracterizan por diferentes formas, colores y tamaños. El efecto ahumado o retrò proporciona a UNIDEA una elegancia evocadora y emocional que hace que un proyecto luminoso sea único. Las composiciones se completan con diferentes accesorios que permiten la personalización del sistema.

Световые решения, использующие как декоративный элемент лампы из дутого стекла со светодиодной нитью. Диммируемые лампы есть в двух вариантах: 5 и 11 ватт и имеют разные характерные формы, цвета и размеры. Дымчатый или ретро эффект придает светильнику UNIDEA тонкую эмоциональную элегантность и тем самым делает его уникальным световым проектом. Композиции включают в себя разные аксессуары для персонализации системы.



Unidea
2018

Unidea Retrò 5



1600 0,2 kg

.70 Retrò

5W E27 LED 250lm 2000K

Dim

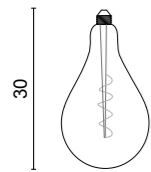

0977/3

Portalampane E27 con cavo 3mt
Lamp holder E27 with cable 3mt

.71 Fumè

0977/5

Portalampane E27 con cavo 5mt
Lamp holder E27 with cable 5mt

.71 Fumè



1600.70 + 0977/...



1601 0,2 kg

.70 Retrò

5W E27 LED 250lm 2000K

Dim

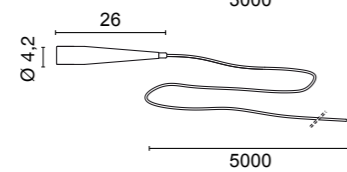
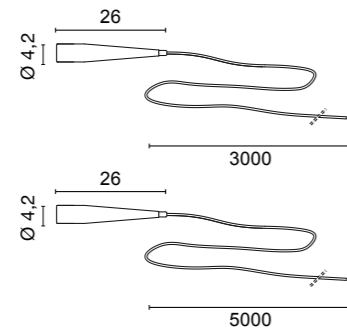
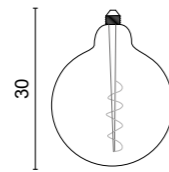

1601.70 + 0977/...



1602 0,2 kg

.70 Retrò

5W E27 LED 250lm 2000K

Dim

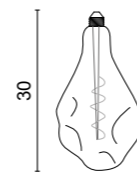

1602.70 + 0977/...

Unidea Retrò 5

0976/1

Rosone - 1 Unidea
Canopy - 1 Unidea

.71 Fumè

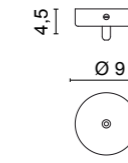

0976/2

Rosone - 2 Unidea
Canopy - 2 Unidea

.71 Fumè

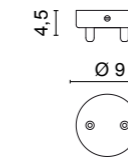

0976/3

Rosone - 3 Unidea
Canopy - 3 Unidea

.71 Fumè

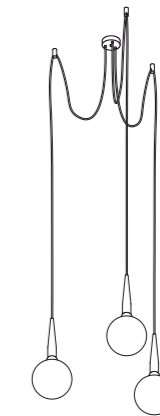
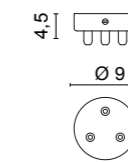

0976/3 + 3 x 0975/1 + 3 x 0977/3 + 3 x 1601

0978/2

2 kg

Rosone - 2 Unidea
Ceiling rose - 2 Unidea

.02 Nero - Black

230V

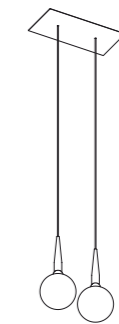
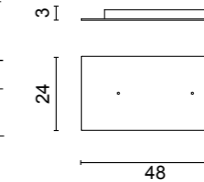

0978/2 + 2 x 0977/3 + 2 x 1601

0978/4

3,8 kg

Rosone - 4 Unidea
Ceiling rose - 4 Unidea

.02 Nero - Black

230V

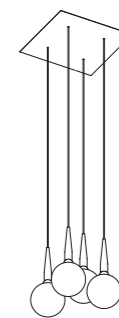
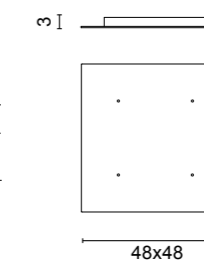

0978/4 + 4 x 0977/3 + 4 x 1601

0975/1

Decentratore per soffitto
Displacement element for ceiling fixing

.00 Trasparente - Clear

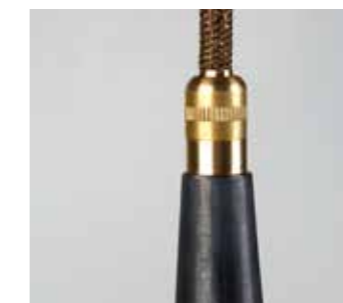
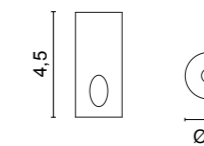

Unidea Retrò 11



1603 0,5 kg

.70 Retrò
11W E27 LED 1000lm 2000K

Dim

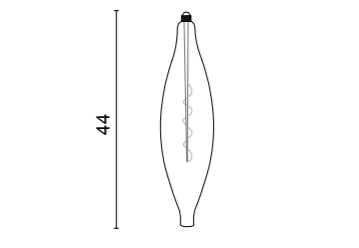

0977/3

Portalampe E27 con cavo 3mt
Lamp holder E27 with cable 3mt

.71 Fumè

0977/5

Portalampe E27 con cavo 5mt
Lamp holder E27 with cable 5mt

.71 Fumè



1603.70 + 0977/...

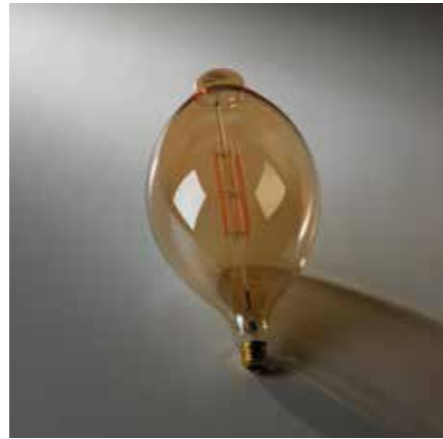

1604 0,5 kg

.70 Retrò
11W E27 LED 1000lm 2000K

Dim

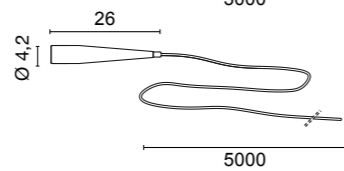
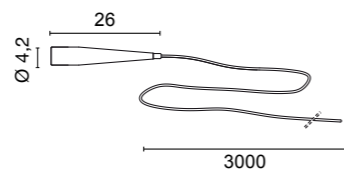
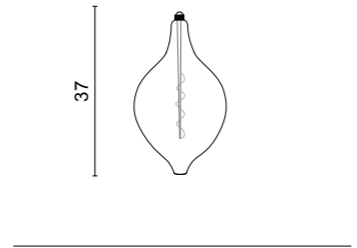

1604.70 + 0977/...

Unidea Retrò 11

0976/1

Rosone - 1 Unidea
Canopy - 1 Unidea

.71 Fumè

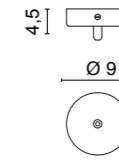

0976/2

Rosone - 2 Unidea
Canopy - 2 Unidea

.71 Fumè

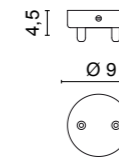

0976/3

Rosone - 3 Unidea
Canopy - 3 Unidea

.71 Fumè

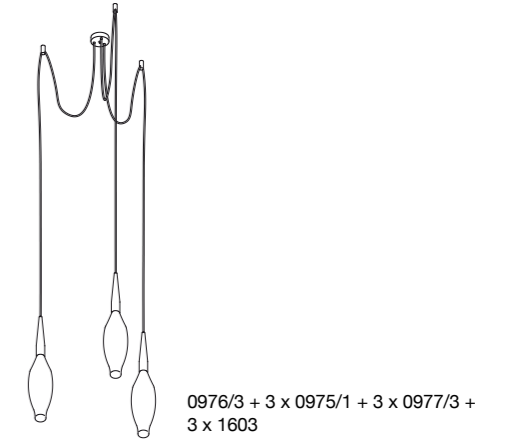
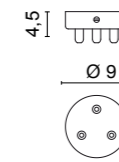

0976/3 + 3 x 0975/1 + 3 x 0977/3 + 3 x 1603

0978/2

2 kg

Rosone - 2 Unidea
Ceiling rose - 2 Unidea

.02 Nero - Black

230V

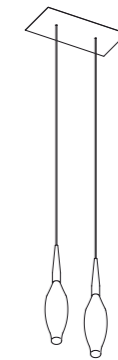
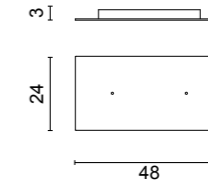

0978/2 + 2 x 0977/3 + 2 x 1603

0978/4

3,8 kg

Rosone - 4 Unidea
Ceiling rose - 4 Unidea

.02 Nero - Black

230V

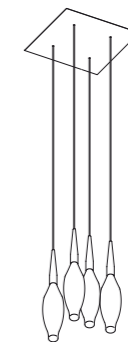
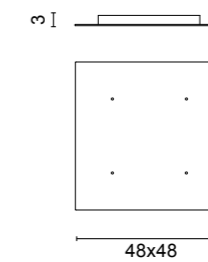

0978/4 + 4 x 0977/3 + 4 x 1603

0975/1

Decentratore per soffitto
Displacement element for ceiling fixing

.00 Trasparente - Clear

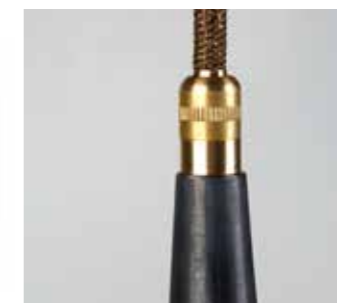
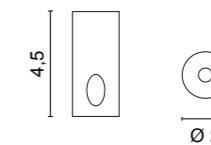



Unidea Fumè 5



1600 0,2 kg

.71 Fumè

5W E27 LED 150lm 2000K

Dim

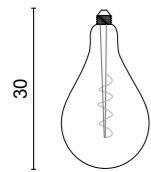

0977/3

Portalampane E27 con cavo 3mt
Lamp holder E27 with cable 3mt

.71 Fumè

0977/5

Portalampane E27 con cavo 5mt
Lamp holder E27 with cable 5mt

.71 Fumè



1601 0,2 kg

.71 Fumè

5W E27 LED 150lm 2000K

Dim

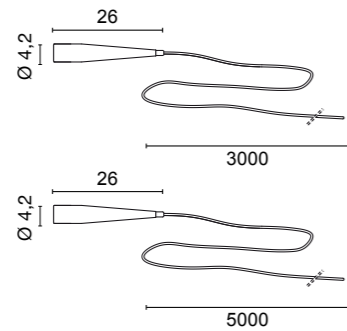
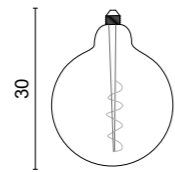

1602 0,2 kg

.71 Fumè

5W E27 LED 150lm 2000K

Dim

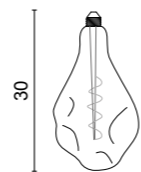

1600.71 + 0977/...



1601.71 + 0977/...



1602.71 + 0977/...

Unidea Fumè 5

0976/1

Rosone - 1 Unidea
Canopy - 1 Unidea

.71 Fumè

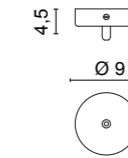

0976/2

Rosone - 2 Unidea
Canopy - 2 Unidea

.71 Fumè

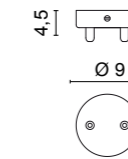

0976/3

Rosone - 3 Unidea
Canopy - 3 Unidea

.71 Fumè

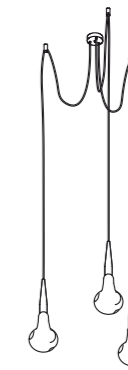
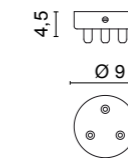

0976/3 + 3 x 0975/1 + 3 x 0977/3 + 3 x 1602

0978/2

2 kg

Rosone - 2 Unidea
Ceiling rose - 2 Unidea

.02 Nero - Black

230V

F

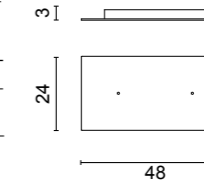

0978/2 + 2 x 0977/3 + 2 x 1602

0978/4

3,8 kg

Rosone - 4 Unidea
Ceiling rose - 4 Unidea

.02 Nero - Black

230V

F

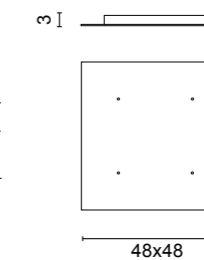

0978/4 + 4 x 0977/3 + 4 x 1602

0975/1

Decentratore per soffitto
Displacement element for ceiling fixing

.00 Trasparente - Clear

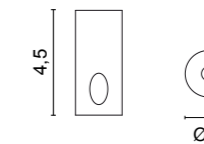





2512 0,9 kg
.70 Retrò

5W E27 LED 250lm 2000K

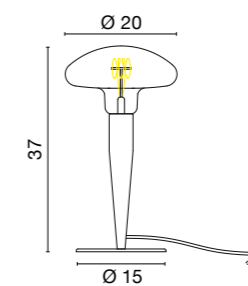
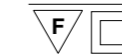



3511 4,3 kg
 .70 Retrò

11W E27 LED 1000lm 2000K



3512 4,3 kg
 .70 Retrò

11W E27 LED 1000lm 2000K

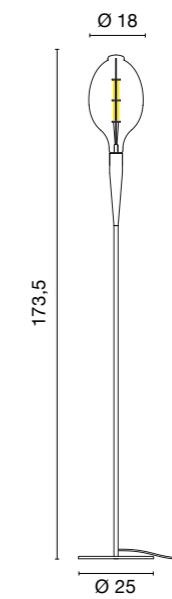
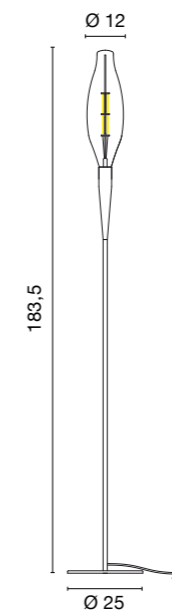

Lampade da parete orientabili, in alluminio e ottone. Disponibili in ottone dorato 24K, cromo, bronzo antico e nickel.

Adjustable wall lamps in aluminum and brass. Available in 24K gold, nickel matt, dark bronze or chromed finish.

Appliques orientables en aluminium et laiton. Disponibles en finition doré 24K, chromé, bronze ancien ou nickel mat.

Verstellbare Wandleuchten aus Aluminium und Messing. Ausführung Gold 24 K, Chrom, antin bronze und Nickel.

Appliques orientables en latón y aluminio. Disponibles en acabado dorado 24K, cromo, bronce antiguo y níquel.

Поворотный настенный светильник в алюминии и латуни. Позолоченный 24к, хромированный, состаренной бронзы или никелированный .



**Ikon LED
Ikon Maxi LED**

design ABS Studio

1984

Ikon LED - Ikon maxi LED

design ABS Studio



.31 Cromato lucido - Shiny chromed

Ikon LED - Ikon maxi LED

design ABS Studio



.21 Dorato lucido - Satin gold



.32 Nickel satinato - Nickel mat

4504 0,70 kg
.21 Dorato lucido - Satin gold
.31 Cromato lucido - Shiny chromed
.32 Nickel satinato - Nickel mat

/WW LED 2,8W 320lm 3000K

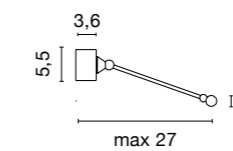
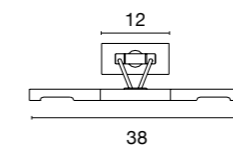

4595 1,1 kg
.21 Dorato lucido - Satin gold
.31 Cromato lucido - Shiny chromed
.32 Nickel satinato - Nickel mat

/WW LED 9W 1414lm 3000K

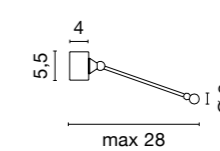
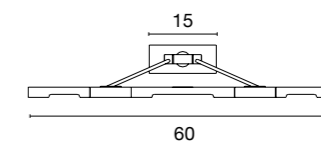



4505 0,60 kg

.21 Dorato lucido - Satin gold

.31 Cromato lucido - Shiny chromed

.32 Nickel satinato - Nickel mat

/WW LED 1,4W 160lm 3000K

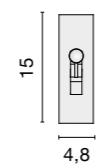
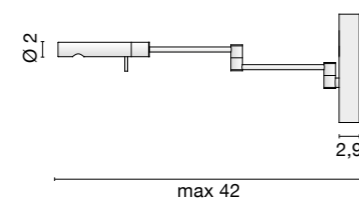

Read
design ABS Studio
2010

Lampada da parete orientabile in alluminio e ottone Disponibile in dorato 24K, cromo e nickel.

Adjustable wall lamp in aluminum and brass. 24Kgold, nickel matt or chromed finish.

Applique orientable en aluminium et laiton. Disponible en finition dore 24K, chromé ou nickel mat.

Verstellbare Wandleuchte aus Aluminium und Messing. Ausführung Gold 24K, Chrom und Nickel.

Applique orientable en latón y aluminio. Disponible en acabado dorado 24K, cromo y níquel.

Поворотный настенный светильник в алюминии и латуни. Позолоченный 24K, хромированный или никелированный

Collezione di lampade da tavolo, terra o parete con struttura in metallo verniciato bianco, base con particolare in cromo. Paralume in tessuto tecnico (ignifugo). La versione da parete è disponibile con o senza luce LED da lettura.

Collection of table, floor or wall lamps, frame in white painted metal, base with chromed detail. Shade in white technical fabric (fireproof). Wall model is available with or without LED reading light.

Collection de lampes de table, applique ou lampadaire avec structure en métal verni blanc, base avec détail chromé. Abat-jour en tissu technique (ignifugé). L'applique est disponible avec ou sans lampe de lecture LED.

Serie von Wand-, Tisch- und Stehleuchten mit Gestell aus weiß lackiertem Metall, Fuß mit verchromtem Detail. Schirm aus technischem (feuerfestem) Stoff. Die Wandleuchte ist mit oder ohne LED leseleuchte bestellbar.

Colección de lámparas de pie, de mesa o pared con estructura de metal pintado blanco. Basamento con particular cromado. Sombra de tejido técnico ignífugo. La versión de pared es disponible con o sin luz de lectura con LED.

Коллекция светильников из белого окрашенного металла, основание с хромированными деталями. Абажур из негорючей ткани. Настенная модель со светодиодным источником света для чтения, или без него.



Alba
design ABS Studio
2011



2117 1,6 kg

.01 Bianco (senza paralume)
White (without shade)

12W E27 LED (art. 0105/12)

42W E27 ECO

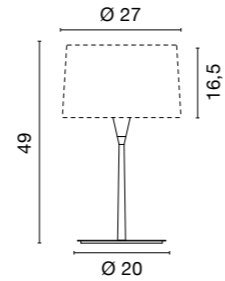

8020

Paralume in tessuto tecnico
bianco ignifugo
Fireproof shade in white technical fabric

.01 Bianco - White

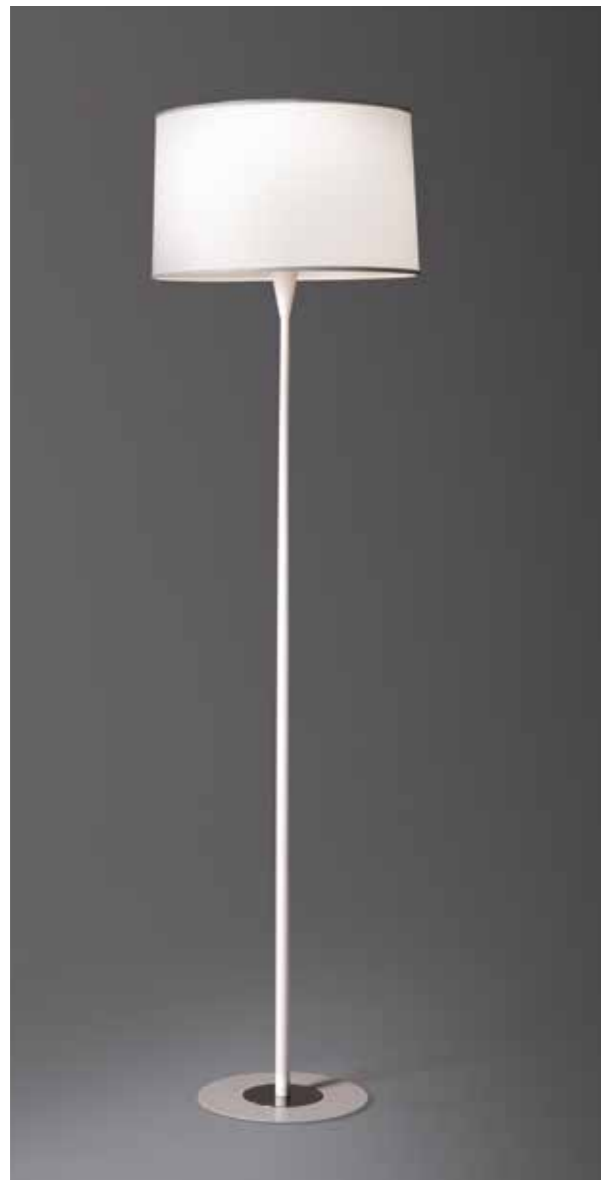

3098 5,8 kg

.01 Bianco (senza paralume)
White (without shade)

12W E27 LED (art. 0105/12)

70W E27 ECO

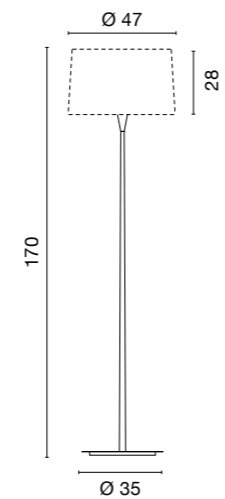

8021

Paralume in tessuto tecnico
bianco ignifugo
Fireproof shade in white technical fabric

.01 Bianco - White



4392 0,7 kg

.01 Bianco (senza paralume)
White (without shade)

12W E27 LED (art. 0105/12)

15W E27 LED (art. 0105/15)

42W E27 ECO

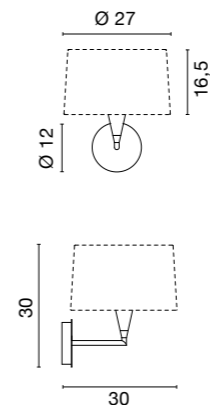

4393 1 kg

.01 Bianco (senza paralume)
White (without shade)

12W E27 LED (art. 0105/12)

15W E27 LED (art. 0105/15)

42W E27 ECO

+ LED 1W 350mA

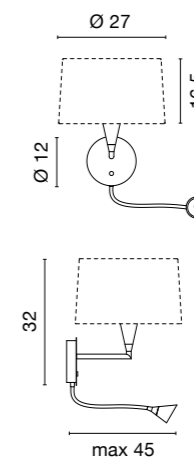

8020

Paralume in tessuto tecnico bianco ignifugo
Fireproof shade in white technical fabric

.01 Bianco - White



Lampade a sospensione, da tavolo, terra e parete con diffusore in vetro soffiato satinato bianco. Optional: Art. 0532: elemento per decentramento.

Suspensions, table, floor and wall lamps with diffuser in white blown glass.
Optional: Art. 0532: displacement component.

Lampes suspension, à poser, Lampadaires et appliques avec diffuseur en verre soufflé satiné opale. Accessoire: Art. 0532: élément pour déplacement.

Pendel-, Tisch, Steh- und Wandleuchten mit Diffusor aus mundgeblasenem Mattglas.
Zubehör: Art. 0532: Befestigung für versetzten Stromauslass.

Lamparas de mesa, de pie, apliques y colgantes de cristal curvado satinado blanco. Accesorio: Art. 0532: elemento para desplazar.

Подвесной, настольный, напольный и настенный светильник из белого дутого стекла.
Как опция: арт. 0532 система для децентрализации.



Dama - Liola
design ABS Studio
2005 - 1998



<p>4209 0,8 kg .57 Vetro bianco - White glass</p> <p>12W E27 LED (<i>art. 0105/12</i>) 15W E27 LED (<i>art. 0105/15</i>) 70W E27 ECO</p> <p>F</p>	<p>4553 1 kg .57 Vetro bianco - White glass</p> <p>/WW LED 13W 1010lm 3000K</p> <p>F </p>
---	---

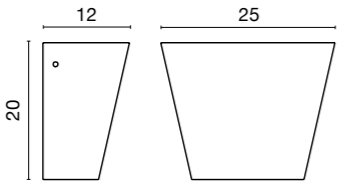

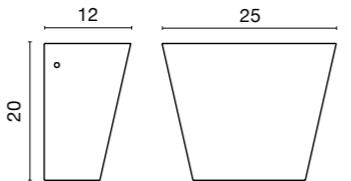



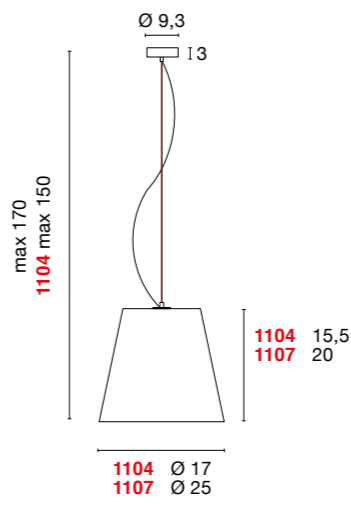

1106 **1107** **1108** **1104**

<p>1104 0,7 kg .57 Vetro bianco - White glass</p> <p>3,5W G9 LED (<i>art. 0092/16</i>) 48W G9 LED</p> <p>F</p>	<p>1106 2,5 kg .57 Vetro bianco - White glass</p> <p>12W E27 LED (<i>art. 0105/12</i>) 15W E27 LED (<i>art. 0105/15</i>) 21W E27 LED (<i>art. 0105/GLOBO</i>) 100W E27 Halolux ECO</p> <p>F</p>
---	--

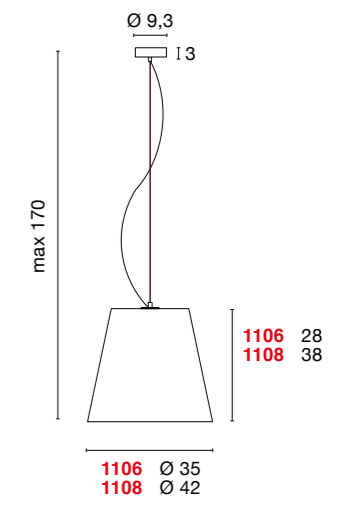



<p>1107 1,2 kg .57 Vetro bianco - White glass</p> <p>12W E27 LED (<i>art. 0105/12</i>) 15W E27 LED (<i>art. 0105/15</i>) 21W E27 LED (<i>art. 0105/GLOBO</i>) 52W E27 ECO</p> <p>F</p>	<p>1108 4,2 kg .57 Vetro bianco - White glass</p> <p>12W E27 LED (<i>art. 0105/12</i>) 15W E27 LED (<i>art. 0105/15</i>) 21W E27 LED (<i>art. 0105/GLOBO</i>) 100W E27 Halolux ECO</p> <p>F</p>
---	--



0532
Elemento per decentramento



2110 1,3 kg
.57 Vetro bianco - White glass

6W E14 LED (art. 0105/MINI)
42W E14 ECO

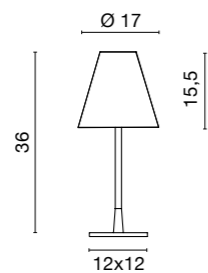

2111 2,9 kg
.57 Vetro bianco - White glass

12W E27 LED (art. 0105/12)
70W E27 ECO

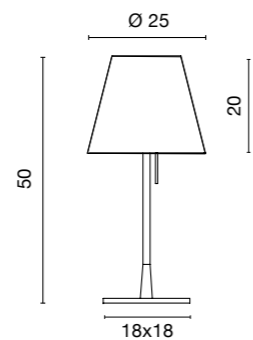

3091 7,3 kg
.57 Vetro bianco - White glass

70W E27 ECO

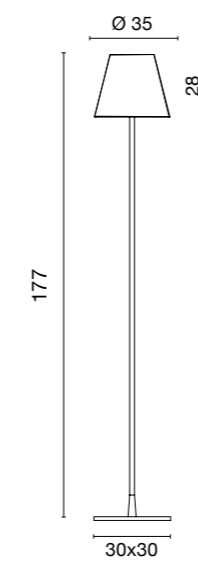

3092 11,7 kg
.57 Vetro bianco - White glass

Up light: 205W E27 ECO

Down light: 2x42W E27 ECO

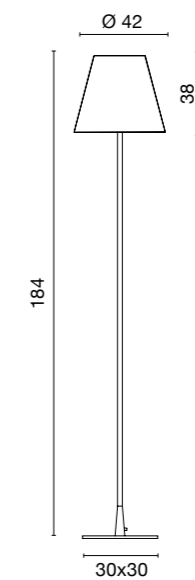



Sospensioni e lampade da appoggio in vetro soffiato satinato bianco. Strutture in nickel satinato. Optional: Art. 0532: elemento per decentramento.

Suspensions and floor lamps in white blown glass. Frames in nickel matt. Optional: Art. 0532: displacement component.

Suspensions et lampes à poser en verre soufflé satiné opale. Structures en nickel satiné. Accessoire: Art. 0532: élément pour déplacement.

Pendel- und Stehleuchten mit Diffusor aus geblasenem Mattglas. Gestell in nickelmatt. Zubehör: Art. 0532: Befestigung für versetzten Stromauslass.

Colgantes y lamparas de pie de cristal soblado satinado blanco. Estructura en metal niquelado satinado. Accesorio: Art. 0532: elemento para desplazar.

Подвесной и напольный светильник из белого дутого стекла. Металлические детали из матового никеля. Как опция: система для децентрализации арт. 0532



Llum
design ASIA design
2000

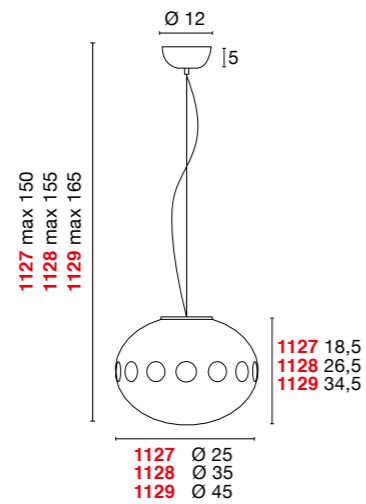

0532
Elemento
per decentramento

1127	2,8 kg
.57 Vetro bianco - White glass	
12W E27 LED (art. 0105/12)	
15W E27 LED (art. 0105/15)	
70W E27 ECO	
F	

1128	3,5 kg
.57 Vetro bianco - White glass	
12W E27 LED (art. 0105/12)	
15W E27 LED (art. 0105/15)	
100W E27 Halolux ECO	
F	

1129	5,4 kg
.57 Vetro bianco - White glass	
12W E27 LED (art. 0105/12)	
15W E27 LED (art. 0105/15)	
100W E27 Halolux ECO	
F	

2107	2,5 kg
.57 Vetro bianco - White glass	
12W E27 LED (art. 0105/12)	
42W E27 ECO	
F	

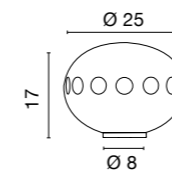

2108	3,1 kg
.57 Vetro bianco - White glass	
100W E27 Halolux ECO	
F □ Dim	

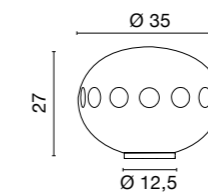

2109	5,1 kg
.57 Vetro bianco - White glass	
100W E27 Halolux ECO	
F □ Dim	

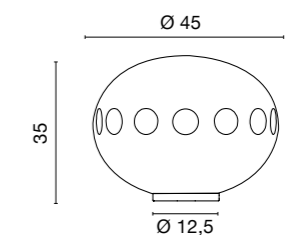



Lampade da soffitto o parete in vetro soffiato bianco satinato.

Ceiling or wall lamps in white satin blown glass.

Plafonniers ou appliques en verre soufflé satiné blanc.

Decken- oder Wandleuchten aus weißem mundgeblasenes Satinglas.

Lamparas de techo o apliques de cristal soblado satinado blanco.

Потолочный, или настенный светильник из дутого белого матового стекла.



Frida
design ABS Studio
1998



4549 1 kg
.57 Vetro bianco - White glass

/WW LED 10W 1200lm 3000K

F IP43

4249 1,4 kg
.57 Vetro bianco - White glass

12W E27 LED (art. 0105/12)

42W E27 ECO

F IP43

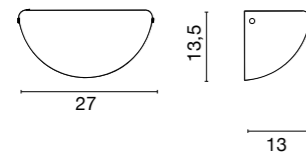

4550 1,8 kg
.57 Vetro bianco - White glass

/WW LED 10W 1200lm 3000K

F IP43

4251 1,7 kg
.57 Vetro bianco - White glass

12W E27 LED (art. 0105/12)

15W E27 LED (art. 0105/15)

42W E27 ECO

F IP43

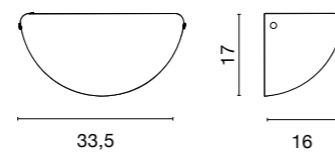

5521 1 kg
.57 Vetro bianco - White glass

/WW LED 10W 1200lm 3000K

F IP40

5150 0,9 kg
.57 Vetro bianco - White glass

12W E27 LED (art. 0105/12)

F IP40

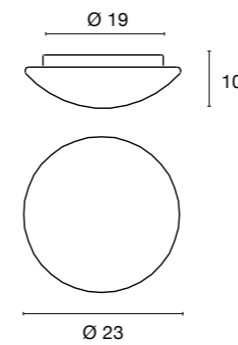

5522 1,4 kg
.57 Vetro bianco - White glass

/WW LED 10W 1200lm 3000K

F IP40

5132 1,3 kg
.57 Vetro bianco - White glass

12W E27 LED (art. 0105/12)

52W E27 ECO

F IP40

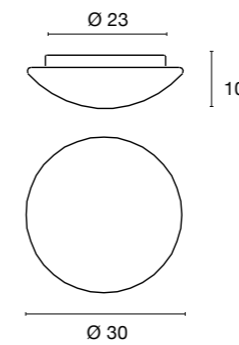

5134 2,3 kg
.57 Vetro bianco - White glass

2x12W E27 LED (art. 0105/12)

2x42W E27 ECO

F IP40

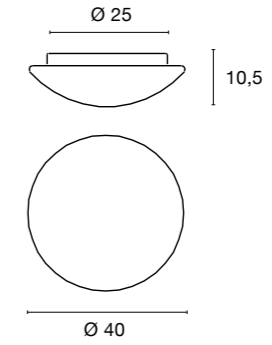

5139 3,2 kg
.57 Vetro bianco - White glass

2x12W E27 LED (art. 0105/12)

2x52W E27 ECO

F IP40

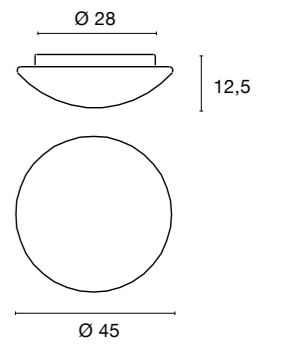

Drim - Drim angolo

design ABS Studio

1995



4545 1 kg
 .57 Vetro bianco - White glass

///WW LED 10W 1200lm 3000K



4092 1 kg
 .57 Vetro bianco - White glass

12W E27 LED (art. 0105/12)

15W E27 LED (art. 0105/15)

100W E27 ECO

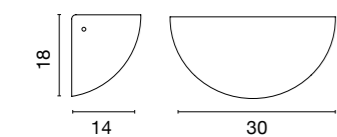

4546 1,8 kg
 .57 Vetro bianco - White glass

///WW LED 10W 1200lm 3000K



4093 1,2 kg
 .57 Vetro bianco - White glass

12W E27 LED (art. 0105/12)

15W E27 LED (art. 0105/15)

100W E27 ECO

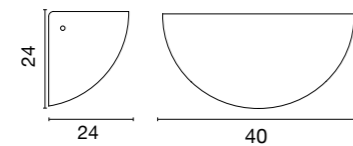

4098 1 kg
 .57 Vetro bianco - White glass

12W E27 LED (art. 0105/12)

15W E27 LED (art. 0105/15)

70W E27 ECO

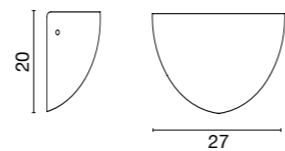

Drim - Drim angolo

design ABS Studio

1995

Lampade da parete in vetro soffiato satinato bianco. Art. 4098 per applicazione ad angolo.
 Con piastre LED a tensione di rete 220-240V.

Wall lamps in satin blown glass, white. Art. 4098 corner fitting.
 With LED plates for main supply 220-240V.

Appliques en verre soufflé satiné blanc Art. 4098 pour installation angulaire. Avec Platine LED à tension du réseau 220-240V.

Wandleuchten aus mundgeblasenem Satinglas weiß. Art. 4098 zur Winkelmontage. Mit LED-module zum Betrieb an Netzspannung 220-240V.

Apliques de cristal soplado blanco satinado. Art. 4098 para montaje en esquina. Con platina de LED para tension de red 220-240V.

Настенный светильник из дутого матового стекла. Арт 4098 для углового монтирования. Со светодиодной платой, подключаемой в сеть 220-240в

4543 1,5 kg
.57 Vetro bianco - White glass

/WW LED 13W 1010lm 3000K



4023 1,5 kg
.57 Vetro bianco - White glass

12W E27 LED (art. 0105/12)

15W E27 LED (art. 0105/15)

70W E27 ECO

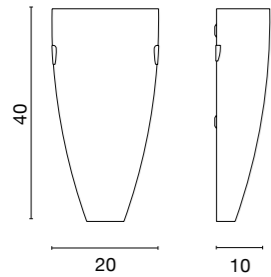

4542 1,2 kg
.57 Vetro bianco - White glass

/WW LED 13W 1010lm 3000K



4021 0,9 kg
.57 Vetro bianco - White glass

12W E27 LED (art. 0105/12)

15W E27 LED (art. 0105/15)

70W E27 ECO

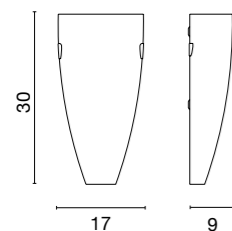

Optional:
0009/P
Griglia di protezione.
Protection net.



Optional:
0009/G
Griglia di protezione.
Protection net.



Lampade da parete in vetro soffiato satinato bianco con particolari cromati. Con piastre LED a tensione di rete 220-240V.

Wall lamps in white blown glass with chromed details.
With LED plates for main supply 220-240V.

Appliques en verre soufflé satiné blanc avec détails chromés.
Avec Platine LED à tension du réseau 220-240V.

Wandleuchten aus geblasenem satiniertem Glas. Metallteile: verchromt.
Mit LED-module zum Betrieb an Netzspannung 220-240V.

Appliques de vidrio soplado satinado blanco con detalles cromados. Con platina de LED para tension de red 220-240V.

Настенный светильник из белого дутого стекла. Детали из хромированного металла со светодиодной платой, подключаемой в сеть 220-240в

Fusò
design ABS Studio
1998



Lampada da plafone/parete con struttura in metallo verniciato bianco e diffusore in vetro soffiato bianco satinato.

Wand-/Deckenleuchte, Struktur aus weiß lackiertem Metall und Diffusor aus weißem Geblasenem satiniertem Glas.

Ceiling/wall lamp, body in white painted metal and diffusor in white satin blown glass.

Lamparas de techo/apliques con difusor de vidrio soplado satinado blanco. Cuerpo de metal pintado blanco.

Lampe à plafond/mur avec structure en métal verni blanc et diffuseur en verre soufflé blanc satiné.

Потолочный или настенный светильник. Корпус из окрашенного в белый цвет металла, Диффузор из белого дутого матового стекла.

5518 1,4 kg
.57 Vetro bianco - White glass

WW LED 8W 670lm 3000K

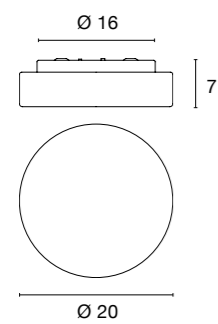

5519 2,5 kg
.57 Vetro bianco - White glass

WW LED 10W 1200lm 3000K

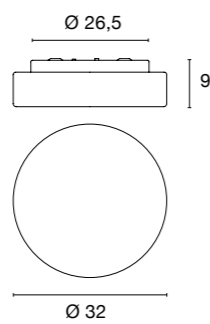

5235 2,8 kg
.57 Vetro bianco - White glass

WW LED 17,3W 2452lm 3000K

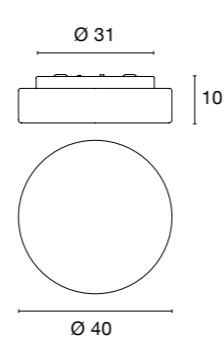



5600 1 kg

.03 Grigio - Grey
.31 Cromato - Chromed

/WW LED 8W 670lm 3000K

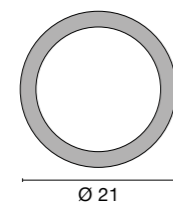
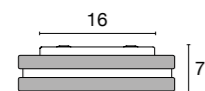
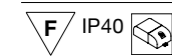

5601 2,8 kg

.03 Grigio - Grey
.31 Cromato - Chromed

/WW LED 10W 1200lm 3000K

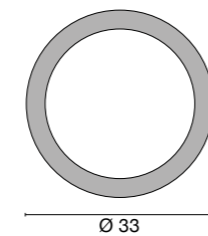
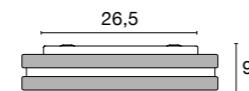
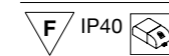

Lampada da parete/soffitto in vetro soffiato bianco satinato, anello in metallo verniciato grigio o cromato.

Ceiling-wall lamp in grey painted or chromed metal . White blown matt glass diffuser.

Applique/plafonnier en verre soufflé satiné blanc anneau en métal chromé ou verni gris

Wand-/Deckenleuchte aus weißem geblasenem satiniertem Glas; Metallring verchromt oder grau lackiert.

Lampara de pared/techo de vidrio soplado blanco satinado y anillo en metal cromado o pintado gris.

Настенный или потолочный светильник из окрашенного или хромированного металла. Белый плафон из матового стекла.

Quinta
design ABS Studio



Optional:
0006
Due griglie di protezione.
Two protection grids.



4178 1,3 kg
.57 Vetro bianco - White glass

120W R7s ECO

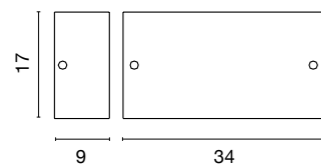

4548 1,5 kg
.57 Vetro bianco - White glass

LED 13W 1010lm 3000K

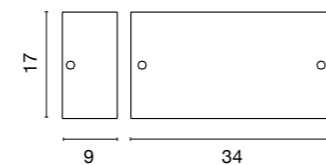

Quinta
design ABS Studio
1995

Lampada da parete in vetro curvato satinato bianco. Particolari in metallo nickel lucido inclusi. Con piastre LED a tensione di rete 220-240V. 2 griglie di protezione disponibili come accessorio (Art.0006).

Wall lamp in curved white satin glass. Metal details in polished nickel included. With LED plates for main supply 220-240V. 2 protection grids are available as accessory (Art.0006).

Applique en verre incurvé satiné blanc. Détails en métal nickelé poli inclus. Avec Platine LED à tension du réseau 220-240V. 2 grilles de protection sont disponibles comme accessoire (Art.0006)

Wandleuchte mit Diffusor aus gebogenem Satinglas, Ausuferung weiß. Mit LED-module zum Betrieb an Netzspannung 220-240V. Inklusiv Metallteile in Nickel poliert. Als Zubehör sind 2 Schutzgitter bestellbar(Art.0006).

Appliques de vidrio curvado, difusor blanco. Detalles en níquel brillo incluidos. Con platina de LED para tension de red 220-240V. 2 grillas de proteccion son disponibles como acesorio (Art.0006).

Настенный светильник из гнутого матового белого стекла. Со светодиодной платой, подключаемой в сеть 220-240в. Детали из полированного никеля. Как аксессуар: защитная решетка (арт.0006).

Mirò LED

design ABS Studio



5595

2 kg

.57 Vetro bianco - White glass

/WW LED 2x13W 2020lm 3000K

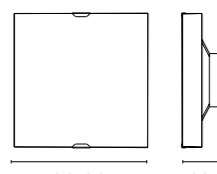

34x34

11

5596

2,7 kg

.57 Vetro bianco - White glass

/WW LED 2x13W 2020lm 3000K

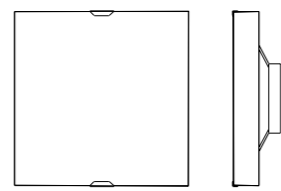

44x44

12

5598

5,9 kg

.57 Vetro bianco - White glass

/WW LED 2x13W 2020lm 3000K

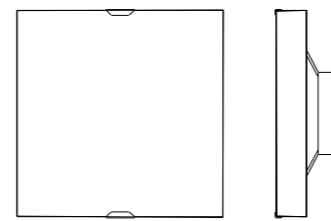

58x58

13



Mirò LED
design ABS Studio
1995

Lampade da parete/plafone in vetro curvato, satinato e verniciato bianco. Particolari in metallo cromato.

Wall or ceiling lamps in curved satin glass, painted white. Details in chromed metal.

Appliques/plafonniers en verre incurvé satiné, verni blanc. Détails en métal chromé.

Wand-/Deckenleuchten. Diffusor aus gebogenem satinglas lackiert, wei. Verchromte Metallteile.

Lamparas de pared y de techo de cristal curvado, pintado blanco. Detalles cromados.

Настенный или потолочный светильник из гнутого матового белого стекла. Детали из хромированного металла.

Flip - Flip Maxi

design ABS Studio

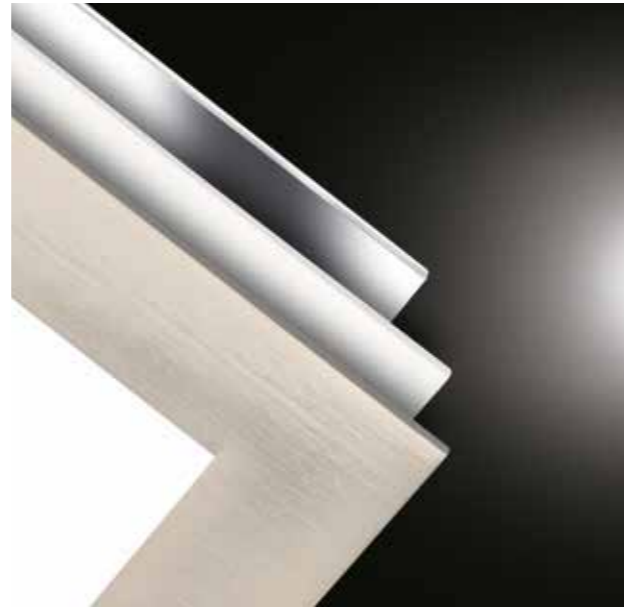

5151 0,6 kg

- .01** Bianco - White
- .31** Cromato - Chromed
- .32** Nickel satinato - Nickel mat

3,5W G9 LED (art. 0092/16)
48W G9 ECO

5533 0,6 kg

- .01** Bianco - White
- .31** Cromato - Chromed
- .32** Nickel satinato - Nickel mat

/WW LED 8W 670lm 3000K
F

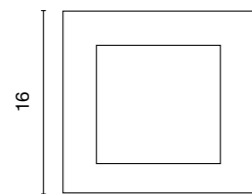
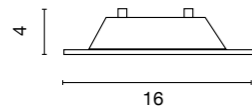
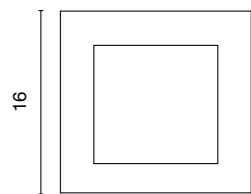
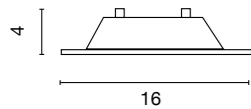

5154 2,1 kg

- .01** Bianco - White
- .31** Cromato - Chromed
- .32** Nickel satinato - Nickel mat

120W R7s ECO (art. 0049/ECO)
F

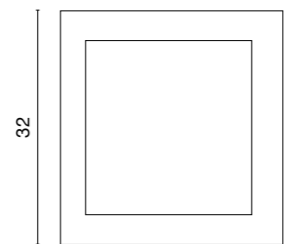
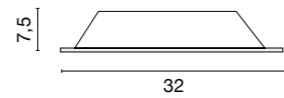

5159 2,3 kg

- .01** Bianco - White
- .31** Cromato - Chromed
- .32** Nickel satinato - Nickel mat

/W LED 17,3W 2330lm 4000K
/WW LED 17,3W 2200lm 3000K
F

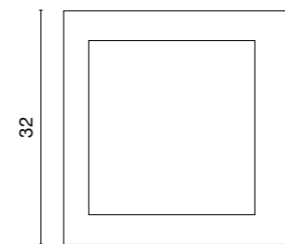
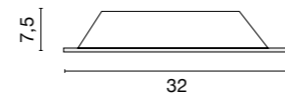

Flip - Flip Maxi
design ABS Studio
2004

Lampade da parete/soffitto con cornice in metallo verniciata, cromata o nichelata. Diffusore in vetro bianco satinato.

Ceiling/wall lamps with metal frame in painted finish, or plated in chrome or nickel matt. White satin glass diffuser.

Appliques/plafonniers avec cadre en métal nickelé, chromé ou verni. Verre diffuseur opale blanc.

Wand-/Deckenleuchten mit Metallrahme. Ausführung: Nickel matt, verchromt oder lackiert. Diffusor aus weißem satiniertem Glas.

Lamparas de pared/techo marco de metal pintado, cromado o nichelado. Difusor de vidrio blanco satinado.

Настенный и потолочный светильник из окрашенного, хромированного или никелированного металла. Диффузор из белого матового стекла.



5013	0,6 kg	5530	0,6 kg
.31 Cromato - Chromed		.31 Cromato - Chromed	

48W G9 ECO



/WW LED 8W 670lm 3000K



5,5

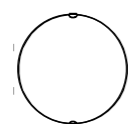

Ø 17

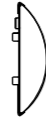

5,5

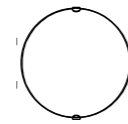

Ø 17



Lampade da soffitto o parete in vetro pressato bianco satinato.

Wall or ceiling lamps in white pressed mattglass.

Appliques ou plafonniers en verre pressé, satiné blanc.

Wand- oder Deckenleuchten aus weissem Mattglas.

Appliques o lamparas de techo de cristal prensado blanco satinado.

Настенный или потолочный светильник из белого прессованного матового стекла.

Helios
design ABS Studio



5525 1 kg	5526 1,6 kg	5527 2,7 kg	5528 4,1 kg
.31 Cromato - Chromed	.31 Cromato - Chromed	.31 Cromato - Chromed	.31 Cromato - Chromed

/WW LED 10W 1200lm 3000K	/WW LED 10W 1200lm 3000K	/WW LED 21,9W 2320lm 3000K	/WW LED 21,9W 2320lm 3000K
 	 	 	 

5008 1 kg	5009 1,6 kg	5010 2,7 kg	5011 4,2 kg
.31 Cromato - Chromed	.31 Cromato - Chromed	.31 Cromato - Chromed	.31 Cromato - Chromed

48W R7s (78mm) ECO	80W R7s (78mm) ECO	120W R7s ECO	230W R7s ECO
			

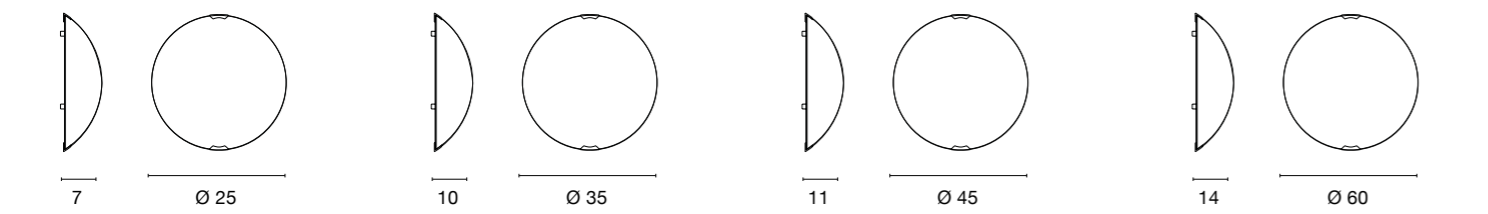

Helios
design ABS Studio
1998

Lampade da parete/plafone in vetro curvato bianco satinato. Particolari in metallo cromato.

Ceiling-/wall lamps in white curved satin glass. Details in chromed metal.

Appliques ou plafonniers en verre incurvé blanc satiné. Détails en métal chromé.

Wand- oder Deckenleuchten aus weißem gebogenem Satinglas. Verchromte Metallteile.

Appliques o lamparas de techo de cristal curvado blanco satinado. Detalles en metal cromado.

Настенный или потолочный светильник из белого гнутого матового стекла. Детали из хромированного металла.

Mir
design ABS Studio



1133 1 kg
.57 Vetro bianco - White glass

12W E27 LED (art. 0105/12)

15W E27 LED (art. 0105/15)

52W E27 ECO

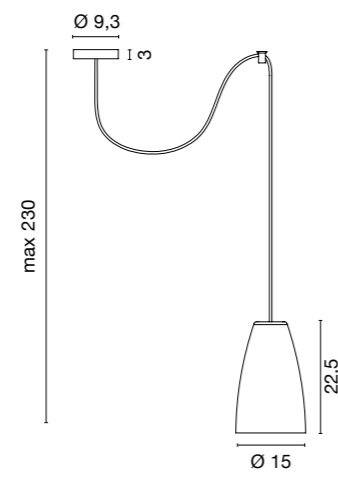

Mir
design ABS Studio
2001

Sospensione in vetro soffiato satinato bianco.
Strutture in metallo verniciato.
Incluso elemento per decentramento.

Suspension lamp in blown matt glass. Frame in painted metal. Displacement component included.

Suspension en verre soufflé satiné. Structures en métal verni. Élément pour déplacement inclus.

Pendelleuchte aus geblasen Mattglas. Gestell aus lackiertem Metall. Inklusiv Versetzungselement.

Colgante de vidrio soplado satinado y cuerpo de metal pintado. Elemento para desplazar incluido.

Подвесной светильник из дутого матового стекла. Детали из окрашенного металла. Элемент для децентрализации.

Lampade a parete con struttura in metallo.
Doppio diffusore esterno in vetro pyrex
trasparente, interno satinato.

Wall lamps with metal structure.
Double diffuser outer in transparent Pyrex
glass, internal diffuser matt.

Appliques avec structure en métal.
Double diffuseurs : extérieur en pyrex
transparent et intérieur en satiné.

Wand/Leuchten mit Struktur aus Metall.
Doppel Diffusor: Außen aus Klarem
Pyrexglass und Innere satiniert.

Colgantes y pared, cuerpo de metal. Doble
difusor: exterior en vidrio pyrex transparente
y interior satinado.

настенный светильник с корпусом
из металла. Внешний диффузор из
прозрачного матового стекла пирекс,
внутренний матовый.



Maya
design ABS Studio
2003



4265 1,3 kg

.50 Cristallo - Crystal

120W R7s (78 mm.) ECO

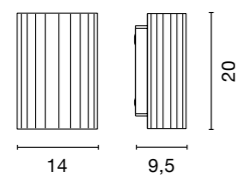

4266 2,4 kg

.50 Cristallo - Crystal

2x80W R7s (78 mm.) ECO

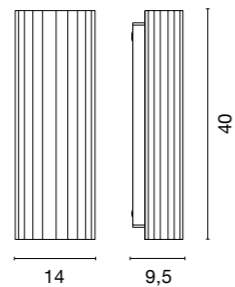

4552 2,9 kg

.50 Cristallo - Crystal

/WW LED 8,4W 1340lm 3000K

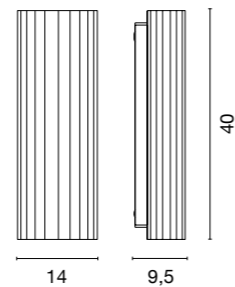

**Lampade da parete e terra in metallo,
finiture: ottone lucido, nickel satinato o
verniciato bianco.
Con moduli LED a tensione di rete
220-240V.**

Wall and floor lamps in metal; Finishes:
polished brass, nickel matt or white varnished.
With LED modules for main supply 220-240V.

Appliques et lampadaire en métal, finition:
laiton poli, nickel satiné ou verni blanc.
Avec modules LED à tension du réseau
220-240V.

Wand- und Stehleuchten aus Metall.
Ausführungen: Messing poliert, Nickelmatt
oder weiß lackiert.
Mit LED-module zum Betrieb an
Netzspannung 220-240V.

Lamparas de pared y de pie de metal.
Acabado: laton pulido, niquel-mat o pintado
blanco.
Con modulo LED para tension de red 220-
240V.

Настенный или напольный светильник
из металла: полированной латуни,
матированного никеля или белого.
Со светодиодной платой, подключаемой в
сеть 220-240в

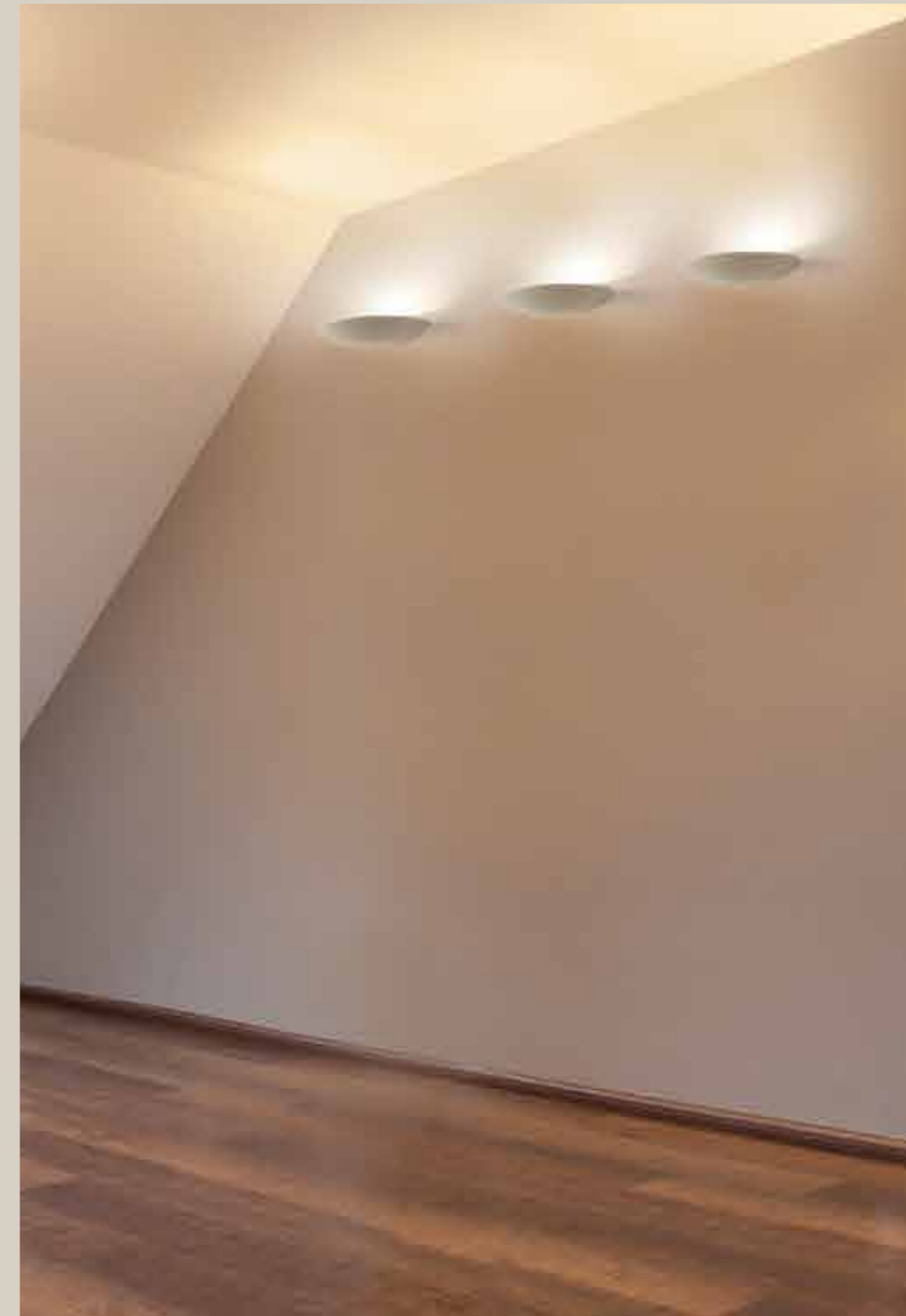

Olimpia LED
design ABS Studio
1981

Olimpia LED

design ABS Studio



4052 0,8 kg

- .01** Bianco - White
- .21** Dorato lucido - Satin gold
- .32** Nickel satinato - Nickel mat

/WW LED 17,5W 1550lm 3000K

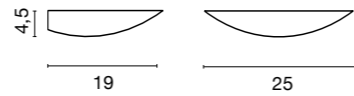

3032 6,8 kg

- .01** Bianco - White
- .21** Dorato lucido - Satin gold
- .32** Nickel satinato - Nickel mat

/WW LED 35W 3100lm 3000K

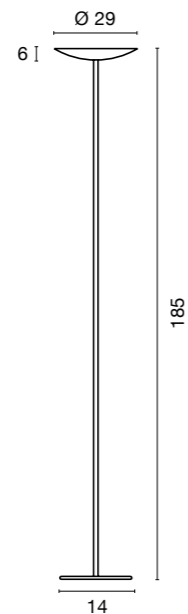

Olimpia LED

design ABS Studio



Disco
design ABS Studio



5017 1,5 kg

.21 Dorato lucido - Satin gold

.31 Cromato - Chromed

2x12W E27 LED (art. 0105/12)

2x42W E27 ECO

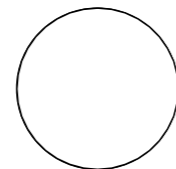
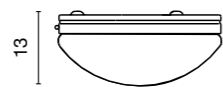

Ø 30



Lampade da plafone o parete in vetro opale soffiato. Montatura in ottone lucido o cromato.

Ceiling or wall lamps in white, blown opal glass. Frame in polished brass or chromed finish.

Plafonniers ou appliques en verre opale soufflé. Structure en finition laiton poli ou chromé.

Decken oder Wandleuchten aus geblasenem Opalglas. Gestell aus Messing poliert oder verchromt.

Appliques o lamparas de techo de cristal opal blanco soblado. Cuerpo de laton pulido o cromado.

Потолочный или настенный светильник из дутого опалового стекла. Детали из латуни: хромированной или полированной.

Disco
design ABS Studio
1983

Luna
design ABS Studio



.01 Bianco - White

.25 Dorato satinato - Satin gold

.31 Cromo - Chromed

.38 Rame lucido - Shiny copper

5038	0,3 kg
.01	Bianco - White
.25	Dorato satinato - Satin gold
.31	Cromato - Chromed
.38	Ramato lucido - Shiny copper

21W E27 LED (art. 0105/GLOBO)

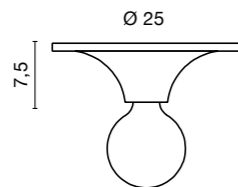

5039	0,4 kg
.01	Bianco - White
.25	Dorato satinato - Satin gold
.31	Cromato - Chromed
.38	Ramato lucido - Shiny copper

21W E27 LED (art. 0105/GLOBO)

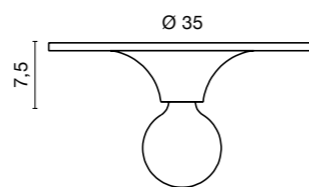

Luna
design ABS Studio
1979

Plafoniere in alluminio disponibili in bianco o in finiture galvaniche.

Aluminum ceiling lamps: white painted or galvanic finishes.

Plafonniers en aluminium: verni blanc ou avec finitions galvaniques.

Deckenleuchten : Ausuferung weiß lackiert oder galvanischen Ausfertigungen.

Lamparas de techo de aluminio : pintado blanco o con acabados galvanicos

Потолочный светильник из алюминия может быть белым или гальванически обработанным.

Indice Alfabetico - Alphabetical Index

Aerostat	281	Matassa	219
Alba	341	Mats	149
Alea / Alea Maxi	203	Maya	385
AleaLED / AleaLED Maxi	193	Megavide	133
Baloon	237	Milady	245
Bureau	29	Minipin	379
Charme	101	Mir	383
Ci	127	Mirò	375
Dama	347	Moonlight	53
Disco	393	Mork / Mork System	229
Drim / Drim angolo	365	Morning	311
Drum	309	Musa	369
Extra	183	Newton / Newton System	107
Fabric	95	Olimpia	389
Flip / Flip Maxi	377	Pavillon	279
Flower	15	Pevera / Pevera System	67
Fokus / Fokus Maxi	295	Phanthom / Phantom maxi	269
Frida	361	Pool	155
Fusò	367	Prêt-à-Porter	289
Giara	283	Pupilla	141
Helios	381	Q Light	61
Ikon LED / Ikon-Maxi LED	335	Quinta	373
Jazz	307	Radar	89
Kalla / Kalla due	211	Rail / Rail UGR / Biemisione	255
Kappa	249	Rail Quadra	161
Lancia	165	Read	339
Lancia Di Achille	21	Ringo	371
Lancia Tonda / System	41	Roc	305
Lei	285	Rulò	189
Liola	347	Siba LED	315
Llum	355	Slice	81
Lui	287	Spirit	121
Luna	395	Unidea	319

Indice Numerico - Numerical Index

1104	Liola 17	349	2110	Dama 15	350	4574	Ci 62	129	5541	Rail	267
1106	Liola 35	349	2111	Dama 25	350	4575	Ci 92	129	5561	AleaLed	199
1107	Liola 25	349	2117	Alba	342	4576	Ci 122	129	5562	Rail Quadra	162
1108	Liola 42	349	2127	Matassa 23	221	4577	Ci 152	129	5563	Fabric 30 cm	97
1127	Llum 25	356	2128	Matassa 34	221	4578	Rail	265	5564	Fabric 40 cm	97
1128	Llum 35	356	2129	Matassa 46	221	4579	Rail	265	5567	Lancia	177
1129	Llum 45	356	2130	Matassa 70	221	4582	Moonlight 50 cm	55	5568	Lancia	177
1133	Mir	382	2502	Kalla	217	4583	Moonlight 70 cm	55	5595	Mirò led	374
1147	Alea	206	2506	Lancia	178	4584	Flower 40 cm.	17	5596	Mirò led	374
1148	Fokus	296	2512	Unidea	331	4585	Flower 50 cm	17	5598	Mirò led	374
1504	Pool	157	3032	Olimpia led	390	4586	Slice	85	5600	Ringo 21	370
1505	Milady	247	3091	Dama 35	351	4587	Bureau	39	5601	Ringo 33	370
1506	Mork Sistema	233	3092	Dama 42	351	4588	Bureau dim.	39			
1507	Mork	231	3098	Alba	342	4590	Q Light 50 cm	63			
1510	Rulò	191	3505	Baloon	241	4591	Q Light 70cm	63			
1512	Kappa	251	3506	Lancia	179	4595	Ikon-maxi LED	337			
1514	Lei	285	3508	Bureau	35	4597	Morning 30 Led	313			
1515	Lui	287	3509	Bureau dim.	35	4598	Morning 60 Led	313			
1516	Prêt-a-Porter	291	3510	Newton	117	4601	Extra	187			
1517	Matassa 23	220	3511	Unidea	333	4602	Extra	187			
1518	Matassa 34	220	3512	Unidea	333	4603	Extra	187			
1519	Matassa 46	220	4021	Fusò 30	366	4604	Extra	187			
1521	Aerostat	281	4023	Fusò 40	366	5008	Helios 25	380			
1523	Giara	283	4052	Olimpia led	390	5009	Helios 35	380			
1524	Phantom	270	4092	Drim 30	364	5010	Helios 45	380			
1525	Phantom	270	4093	Drim 40	364	5011	Helios 60	380			
1526	Phantom maxi	271	4098	Drim Angolo	364	5013	Minipin	378			
1527	Phantom maxi	271	4178	Quinta	372	5017	Disco	392			
1530	Megavide 65 cm	135	4209	Liola	348	5038	Luna	394			
1531	Megavide 90 cm	135	4249	Frida 26	362	5039	Luna	394			
1532	Megavide 110 cm	135	4251	Frida 32	362	5132	Frida 30	363			
1535	Spirit	123	4265	Maya	386	5134	Frida 40	363			
1540	Lancia	167	4266	Maya	386	5139	Frida 45	363			
1541	Rail	257	4281	Alea	205	5150	Frida 20	363			
1542	Rail	257	4282	Alea	204	5151	Flip	376			
1545	Rail	259	4286	Fokus	299	5154	Flip Maxi	376			
1546	RAIL UGR	263	4287	Fokus	298	5159	Flip Maxi Led	376			
1547	RAIL UGR	263	4331	Siba led	317	5174	Fokus	301			
1550	Baloon	239	4333	Siba led	317	5176	Alea	209			
1551	Pevera	69	4392	Alba	343	5185	Alea	209			
1552	Slice	83	4393	Alba	343	5186	Fokus	301			
1553	Slice Maxi	83	4501	Kalla	213	5227	Kappa	253			
1554	Bureau	30	4504	Ikon Led	337	5229	Matassa 23	225			
1555	Fabric 30 cm	96	4505	Read	338	5230	Matassa 34	225			
1556	Fabric 40 cm	96	4525	Baloon	243	5233	Prêt-a-Porter	293			
1558	Pavillon	279	4533	Matassa 34	224	5234	Musa 40	368			
1560	Extra	185	4534	Matassa 46	224	5235	Musa 40 led	368			
1561	Rail Quadra	163	4540	Kalla due	213	5236	Phanthom led	272			
1562	Lancia Tonda	45	4541	Kalla due	213	5237	Phanthom led	272			
1563	Lancia Tonda	45	4542	Fusò led	366	5239	Phanthom maxi led	273			
1564	Lancia Tonda	45	4543	Fusò led	366	5240	Phanthom maxi led	273			
1565	Lancia Cavo	169	4545	Drim led	364	5513	Alea Maxi	201			
1567	Lancia di Achille	23	4546	Drim led	364	5514	Fokus Maxi LED	303			
1568	Pevera System	71	4548	Quinta led	372	5518	Musa led	368			
1569	Pevera System	71	4549	Frida 26 led	362	5519	Musa led	368			
1570	Radar	91	4550	Frida 32 led	362	5520	Drum	308			
1571	Radar	91	4552	Maya 40 led	386	5521	Frida led	363			
1590	Newton Sospensione	109	4553	Liola	348	5522	Frida led	363			
1591	Newton Sosp. Syst.	111	4561	AleaLed	195	5525	Helios led	380			
1592	Newton Sosp. Syst.	111	4562	Newton Spot	119	5526	Helios led	380			
1593	Charme	103	4564	Mats	151	5527	Helios led	380			
1600	Unidea	320	4565	Mats Maxi	151	5528	Helios led	380			
1601	Unidea	320	4567	Lancia	173	5530	Minipin Led	378			
1602	Unidea	320	4568	Lancia	173	5533	Flip led	376			
1603	Unidea	322	4569	Lancia	173	5536	Megavide 65 cm	134			
1604	Unidea	322	4570	Lancia	176	5537	Megavide 90 cm	134			
2107	Llum 25	357	4571	Pupilla	143	5538	Jazz	306			
2108	Llum 35	357	4572	Pupilla	143	5539	Roc	304			
2109	Llum 45	357	4573	Pupilla tavolo	145	5540	Rail	267			



I nostri prodotti sono costruiti in conformità alle norme europee CEI-EN 60598 e, come tali, recano la marcatura CE.

Our fittings are manufactured in conformity with the european standard CEI-EN 60598 and, consequently, get the mark CE.

EDITION

May 2018 © All rights reserved

ART DIRECTION

U.T. Ego luce

LAYOUT, GRAPHICS and PHOTOS

Bordegoni s.r.l.

PRINTING

Rotolito Lombarda - Italy

Thanks to:

Assembly

Unsplash

Studio Mussapi

Ego luce s.r.l. si riserva la facoltà di modificare, in qualsiasi momento e senza preavviso, le caratteristiche tecniche dei modelli illustrati nel presente catalogo.

I colori si intendono indicativi.

Ego luce s.r.l. reserves the right to change, at any time and without prior warning, the technical specification of any product illustrated in this catalogue.

Colours are simply indicative of the real nuance.

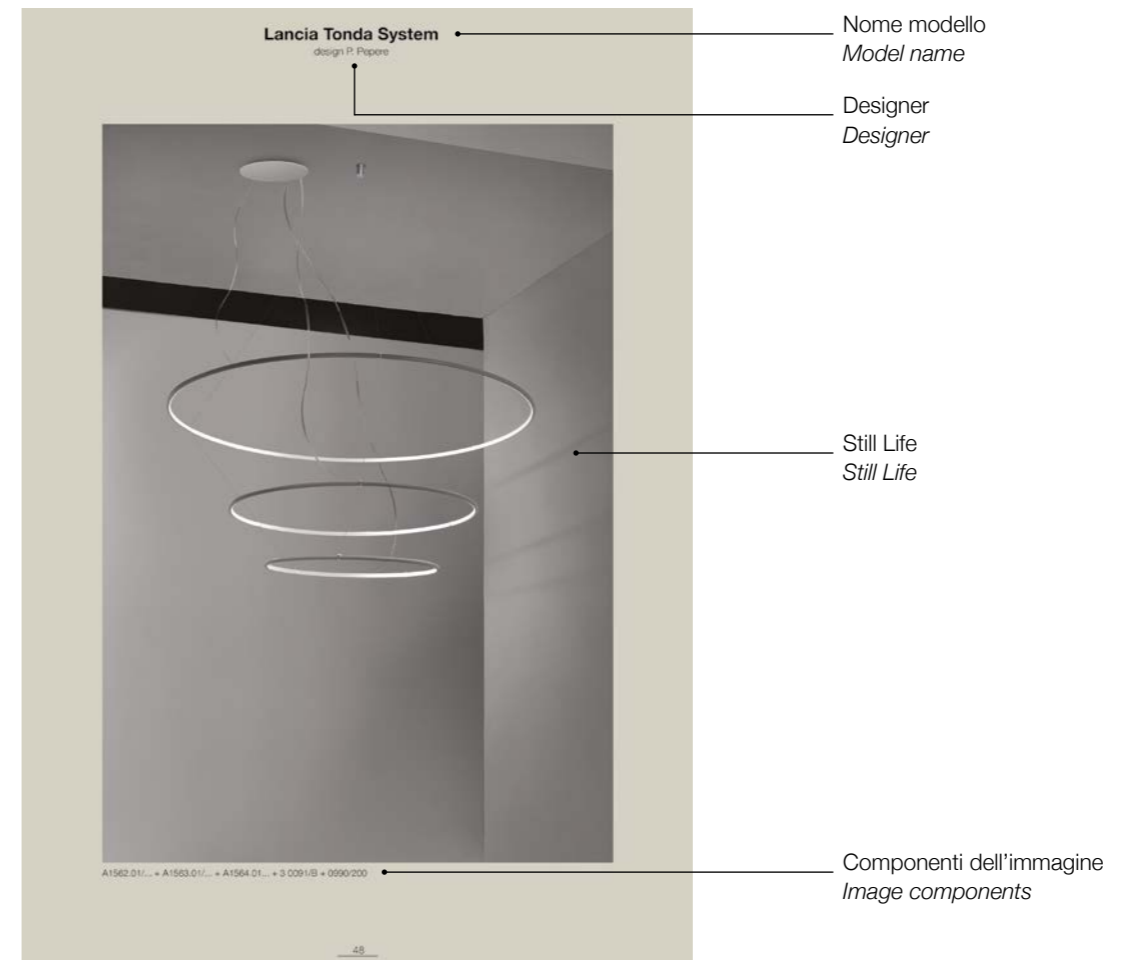

Accessori
Accessories

0990/150	2 kg	0990/200	2 kg
Rosone completo di alimentatore 150W Ceiling rose with converter 150W		Rosone completo di alimentatore 2x100W Ceiling rose with converters 2x100W	
.01 Bianco - White		.01 Bianco - White	
.02 Nero - Black		.02 Nero - Black	
50/60Hz 220-230V - 150W		50/60Hz 220-230V - 2x100W	

Disegno tecnico
Technical drawing

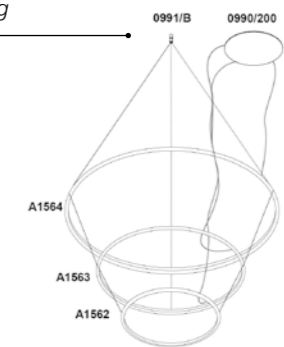

Dati tecnici
Technical data

Codice prodotto
Product code

Codice Code	Ø cm	watt	Finitura Finishes	Lumen Lumen					
				LED color 2700K	Lm	LED color 3000K	Lm	LED color 4000K	Lm
A1562	70	37,5	.01 Bianco - White	/XW	4479	/WW	4958	/W	5000
A1562	70	37,5	.02 Nero - Black	/XW	4479	/WW	4958	/W	5000
A1562	70	37,5	.25 Dorato satinato - Shiny gold	/XW	4479	/WW	4958	/W	5000
A1562	70	37,5	.31 Cromato - Chromed	/XW	4479	/WW	4958	/W	5000
A1563	100	54	.01 Bianco - White	/XW	6450	/WW	7140	/W	7200
A1563	100	54	.02 Nero - Black	/XW	6450	/WW	7140	/W	7200
A1564	150	81	.01 Bianco - White	/XW	9675	/WW	10710	/W	10800
A1564	150	81	.02 Nero - Black	/XW	9675	/WW	10710	/W	10800



MADE IN ITALY

EGOLUCE s.r.l. Via I. Newton, 12 - 20016 Pero - Milano - Italy - Tel. +39 02339586.1 - Italia fax +39 023535112
Int. fax +39 0233911087 E-mail: info@egoluce.com - Int. E-mail: infoworld@egoluce.com - www.egoluce.com